



Nu  edical



www.numedical.com.au | Ph: 1300 998 224

HOT & NEW!

Try our "HOT & NEW" products for just \$0.99 per item.

FREE DELIVERY!

Get free shipping when you order over \$299 (inc GST).

FREE SAMPLES!

Try our products marked with the "FREE SAMPLE" label.

TGA APPROVED!

All our products are approved by TGA.

MONEY BACK GUARANTEE!

If you are not completely satisfied with our products, we will offer a 100% refund.

SAME-DAY DISPATCH!

Orders received prior to 12.00pm will be dispatched on the same day.

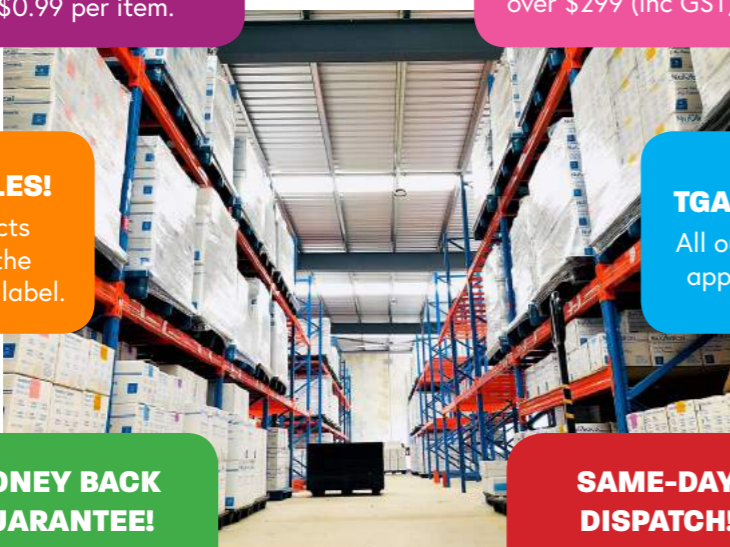

LOW PRICE GUARANTEE

Our customers are spoilt for choice when it comes to different colours and sizes. What's even better is our irresistible low prices! NuMedical are committed to offering premium quality products at very competitive prices.

FREE SAMPLES

We make the process of finding the right products an easy one for dental professionals. We encourage our customers to try products that are marked with the "FREE SAMPLES" label.

SAME-DAY DISPATCH

All orders received prior to 12.00pm on a normal business day will be dispatched from our warehouse on the same day!

FREE DELIVERY

We offer free delivery for orders over \$299 (inc GST), Australia-wide!

MONEY BACK GUARANTEE

If you are not completely satisfied with our products, we will offer a 100% refund. For more information, please read more about our "Refund Policy."

SKIP THE QUEUE, ORDER ONLINE!

As a dental professional, we understand that time is precious. Ordering dental supplies is now so much simpler, quicker and easier! Skip the phone queue and place your orders with our fast and easy-to-use website: www.numedical.com.au

EXCEPTIONAL CUSTOMER CARE

We not only take pride in the quality of products that we supply to our customers, the team here at NuMedical always strives to deliver exceptional customer care, to ensure that all your needs and queries are taken care of. Please do not hesitate to give us your feedback, we love hearing from our customers! Email orders@numedical.com.au or call 1300 998 224. Our office is open from 9am - 5pm, Monday to Friday.

FAST, EASY AND SECURE ORDERING

You can order from NuMedical in one of three easy ways:

1. Call us on 1300 998 224 during office hours to speak with one of our friendly and knowledgeable Account Managers. Our Account Managers are committed to providing you with the latest product information and to answer any queries that you may have. Our office is open from 9am - 5pm, Monday to Friday.
2. Send your orders through to orders@numedical.com.au, and you will receive an Order Confirmation from one of our Account Managers.
3. Order online on www.numedical.com.au. It's quick, easy and secure!

SHIPPING AND DELIVERY POLICY

Once your order and payment have been processed, you will receive an email with an Order Confirmation from NuMedical Pty Ltd. Once your items have been dispatched, you will receive an email with your shipment tracking number. NuMedical Pty Ltd provides free delivery if your total order amounts to more than \$299.00 (inc GST). NuMedical Pty Ltd reserves the right to make changes to the freight-free policy without notice. All orders received prior to 12.00pm on a normal business day will be dispatched from our warehouse on the same day. Note: Same-day dispatch is subject to stock availability.

REFUND POLICY

NuMedical Pty Ltd offers "Money Back Guarantee" return on goods sold within 30 days from the date of purchase. To make a claim, please call us on 1300 998 224 or email orders@numedical.com.au to speak with a NuMedical Account Manager to arrange for a "Return Authorisation". A Return Label will be emailed to you within 24 hours. Please affix the Return Label onto the product. The product must be returned to NuMedical Pty Ltd in its original packaging, unmarked with all of its contents as shipped. NuMedical Pty Ltd can arrange for the product to be picked-up, however, the return freight cost will be at your own cost.

PRICING INTEGRITY

All prices in this product catalogue are current at the time of publication. We make every effort to maintain our everyday low prices, however, market conditions and prices of raw materials may affect our pricing. Prices would also need to be adjusted in the event of typo errors in this catalogue. We encourage our customers to view our latest pricings on our website: www.numedical.com.au

WARRANTY

To make a warranty claim, firstly check if the product comes with a product warranty guarantee. Warranty claims must be made within the specified time. To make a claim, please call us on 1300 998 224 or email orders@numedical.com.au to speak with a NuMedical Account Manager for assistance.

PAYMENT TERMS

All orders will have to be prepaid prior to delivery. NuMedical Pty Ltd accepts Debit, Visa and Master cards, and cheque payments. Please call us on 1300 998 224 or email orders@numedical.com.au to apply for a 30-day credit account. Credit applications are subject to credit approval.

PRIVACY POLICY

We will only use personal information provided by you for the purposes for which it was collected and we will not disclose your personal information to a third party, except when it is required to facilitate a service you have requested. We will remove personal information from our systems where it is no longer required. We ensure that your personal information will not be disclosed unless law requires it or to prevent or investigate suspected unlawful activity.

CONTACT US

NuMedical Pty Ltd
 9-13 Hender Avenue Magill SA 5072
 Toll Free Call: 1300 998 224
 Toll Free Fax: 1300 998 234
 Email: orders@numedical.com.au
 Website: www.numedical.com.au



Surprise!

You would have received a goodie bag together with the NuMedical product catalogue. Below is some information about the samples that you have received! We hope that you will enjoy using them!



Oatmeal

**Happy Coats
Latex Exam Gloves**

Pamper your hands with Colloidal Oatmeal Active Therapeutic System. Recognised by FDA as a skin protectant, ideal if you suffer from dry hands. Powder-free, full-textured. See page 93 - 96 for our complete range of dental gloves.

Size	Quantity	Code	Colour
XS	1 pair	#990044	Light Green
S	1 pair	#990045	Green



Aloe Vera

**Aloe Care
Latex Exam Gloves**

Pamper your hands with Aloe Vera coated latex exam gloves to keep your hands soft and smooth all day long! Non-sterile, powder-free, full-textured and ambidextrous latex exam gloves. See page 93 - 96 for our complete range of dental gloves.

Size	Quantity	Code	Colour
XS	1 pair	#990040	Natural
S	1 pair	#990041	Latex



Latex-Free

**Beesure Forest
Nitrile Exam Gloves**

Soft and stretchy nitrile formulation with excellent tactile sensitivity. Super compact packaging reduces storage space. Latex-free and powder-free. See page 93 - 96 for our complete range of dental gloves.

Size	Quantity	Code	Colour
S	1 pair	BE2946	Forest Green
M	1 pair	BE2947	Green



Latex-Free

**Beesure Canyon
Nitrile Exam Gloves**

Soft and stretchy nitrile formulation with excellent tactile sensitivity. Super compact packaging reduces storage space. Latex-free and powder-free. See page 93 - 96 for our complete range of dental gloves.

Size	Quantity	Code	Colour
S	1 pair	BE2916	Peach
M	1 pair	BE2917	Peach



Face Masks

See page 113 - 115 for our complete range of face masks.

Quantity	Code	Level	Colour
1 pc	#992206	2	Pink Zoe
1 pc	#992280	2	Blue
1 pc	#992263	3	Black



Dental Bibs

2-Ply heavy tissue patient bibs with poly-backing and vertical embossing. Optimal absorbency and barrier protection. Size: 330mm (L) x 450mm (W). See page 41-43 for our complete range of bibs.

Quantity	Code	Colour
1 pc	#990158-2	Blue Zoe
1 pc	#990212	Pink

LIKE

OUR PRODUCTS?

PLACE YOUR ORDERS HERE

www.numedical.com.au



CONTENTS

CONTENTS

Hot & New 1 - 4

Anaesthetics Organisers 5

Articulating 6

Burs and Accessories 7 - 18

Cheek Retractors 19 - 20

Clinic Organisers 21 - 34

Composite and Cement Accessories 35 - 40

Disposables 41 - 50

Endodontics 51 - 64

Evacuation 65 - 70

CONTENTS

CONTENTS

Equipment and Accessories 71 - 92

Gloves and Dams 93 - 96

Impression 97 - 106

Infection Control 107 - 120

Instruments and Accessories 121 - 122

Matrix Accessories 123 - 124

Orthodontics 125 - 146

Preventatives 147 - 152

Sundries 153 - 156

X-Ray 157 - 159

NuMedical

NuMedical



HOT & NEW Promo Terms and Conditions

*Subject to change without notice

Total purchase in one receipt must be over \$199 inc GST (excludes delivery charges):

Choose maximum **TWO Hot & New** items! Page 1 - 4

Total purchase in one receipt must be over \$299 inc GST (excludes delivery charges):

Choose maximum **FIVE Hot & New** items! Page 1 - 4

Only \$0.99 per item!

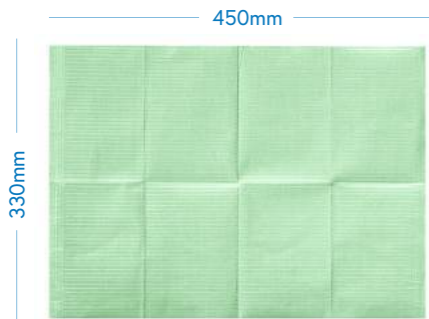

\$0.99 /bag

20% HEAVIER THAN REGULAR 2+1 BIBS!

Patient Bibs, 2-Ply Heavy Tissue + Poly

100pcs/bag

2-Ply heavy tissue patient bibs with poly-backing and vertical embossing. Optimal absorbency and barrier protection. Size: 330mm (L) x 450mm (W) See page 41-43 for our complete range of bibs.

Code	Colour
#990210a	Teal
#990211a	Blue
#990212a	Pink
#990213a	Green
#990214a	Purple
#990216a	Yellow
#990217a	White



\$0.99 /box

Self-Tape Patient Towel, Medium

100pcs/box

Self-tape patient towel with adhesive tab that eliminates the need for chains/clips. Simply position towel around the neck and apply pressure to the tab. Does not leave behind glue. Maximum infection control and patient comfort. Size: 560mm (L) x 430mm (W) See page 41-43 for our complete range of bibs.

Code	Colour
#990248a	Blue
#990249a	Pink
#990250a	Green
#990251a	Yellow
#990252a	White



\$0.99 /box

Self-Tape Patient Towel - Eco

100pcs/box

Self-tape patient towel (1-ply tissue with poly-backing) with adhesive tab that eliminates the need for chains/clips. Simply position towel around the neck and apply pressure to the tab. Does not leave behind glue. Size: 560mm (L) x 430mm (W) See page 41-43 for our complete range of bibs.

Code	Colour
#990256a	Blue

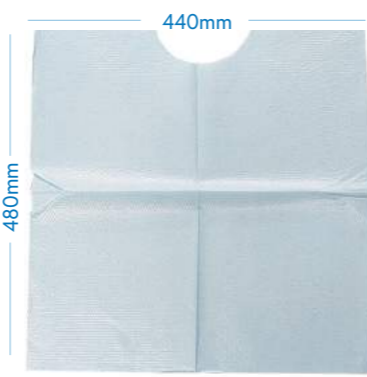

\$0.99 /box

Contour Patient Towel

100pcs/box

Contour patient towel 1-ply tissue with poly-backing. The neck contour provides a comfortable fit for patients. Size: 480mm (L) x 440mm (W) See page 41-43 for our complete range of bibs.

Code	Colour
#990255a	Blue



\$0.99 /box

EcoBee

Latex-Free

Beesure Black Nitrile Exam Gloves

200pcs/box

Gorgeous black nitrile gloves that not only look good but feel good! Soft and stretchy nitrile formulation with excellent tactile sensitivity. Super compact packaging reduces storage space. Latex-free and powder-free. See page 93 - 96 for our complete range of dental gloves.

Size	Code	Colour
XS	BE1165a	Black
S	BE1166a	
M	BE1167a	
L	BE1168a	



\$0.99 /box

EcoBee

Latex-Free

Beesure Canyon Nitrile Exam Gloves

200pcs/box

Soft and stretchy nitrile formulation with excellent tactile sensitivity. Super compact packaging reduces storage space. Latex-free and powder-free. See page 93 - 96 for our complete range of dental gloves.

Size	Code	Colour
XS	BE2915a	Peach
S	BE2916a	
M	BE2917a	
L	BE2918a	



\$0.99 /box

EcoBee

Latex-Free

Beesure Forest Nitrile Exam Gloves

300pcs/box

Soft and stretchy nitrile formulation with excellent tactile sensitivity. Super compact packaging reduces storage space. Latex-free and powder-free. See page 93 - 96 for our complete range of dental gloves.

Size	Code	Colour
XS	BE2945a	Forest Green
S	BE2946a	
M	BE2947a	
L	BE2948a	



\$0.99 /box

EcoBee

Latex-Free

Beesure Cloud Nitrile Exam Gloves

300pcs/box

Soft and stretchy nitrile formulation with excellent tactile sensitivity. Super compact packaging reduces storage space. Latex-free and powder-free. See page 93 - 96 for our complete range of dental gloves.

Size	Code	Colour
XS	BE2935a	White
S	BE2936a	
M	BE2937a	
L	BE2938a	



\$0.99 /box

EcoBee

Beesure Latex Exam Gloves

100pcs/box

Smooth polymer interior coating for improved moist or dry donning. Full-hand micro-textured for optimal grip. Powder-free, chlorine-free and low protein content to minimise exposure to allergens and irritants. See page 93 - 96 for our complete range of dental gloves.

Size	Code	Colour
XS	BE2815a	Natural Latex
S	BE2816a	
M	BE2817a	
L	BE2818a	



\$0.99 /bag

EcoBee

Beesure Surgical Latex Exam Gloves

10 pairs/bag

Hand-specific fitted gloves for use in sterile environments. Smooth polymer interior coating for improved moist or dry donning. Full-hand micro-textured for optimal grip. Powder-free, chlorine-free and protein-rated to minimise exposure to allergens and irritants. Available in 5 sizes for the perfect fit. See page 93 - 96 for our complete range of dental gloves.

Size	Code	Colour
6.0	BE3160a	Natural Latex
6.5	BE3165a	
7.0	BE3170a	
7.5	BE3175a	
8.0	BE3180a	



\$0.99 /box
EcoBee

Beesure Dental Dams, 5" x 5"
52pcs/box

Powder-free rubber dams with low protein content to minimise exposure to allergens and irritants. Size: 5" x 5". Option of plain or mint-scented dams. See page 95 for dental dams and frames.

Code	Scent
BE102a	Plain
BE105a	Mint



\$0.99 /box
EcoBee

Beesure Dental Dams, 6" x 6"
36pcs/box

Powder-free rubber dams with low protein content to minimise exposure to allergens and irritants. Size: 6" x 6". Option of plain or mint-scented dams. See page 95 for dental dams and frames.

Code	Scent
BE112a	Plain
BE115a	Mint



\$0.99 /box

Ebony Face Mask, Anti-Fog
40pcs/box

Level 3 single use 4-ply ear loop black face mask with anti-fog barrier strip which prevents fogging of eyewear. Latex-free, lint-free and fibreglass-free. Size: 175mm (L) x 90mm (W) See page 113 - 115 for our complete range of face masks.



Code	Colour
#992264a	Black



\$0.99 /box

Premium Print Face Mask
50pcs/box

Level 2 single use 3-ply ear loop face mask. Latex-free, lint-free and fibreglass-free. Choose from 7 different beautiful prints. Size: 175mm (L) x 90mm (W) See page 113 - 115 for our complete range of face masks.s.

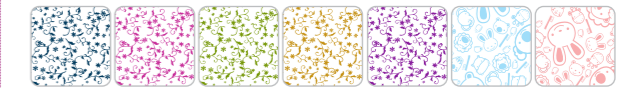

Code	Colour
#992200a	Floral Blue
#992201a	Floral Pink
#992202a	Floral Green
#992203a	Floral Yellow
#992204a	Floral Purple
#992205a	Blue Zoe
#992206a	Pink Zoe



\$0.99 /bag

Happy Coats Latex Exam Gloves
100pcs/box

Pamper your hands with Colloidal Oatmeal Active Therapeutic System. Recognised by FDA as a skin protectant, ideal if you suffer from dry hands. Powder-free, full-textured. See page 93 - 96 for our complete range of dental gloves.

Size	Code	Colour
XS	#990044a	
S	#990045a	Light Green
M	#990046a	Green
L	#990047a	



\$0.99 /box

Happy Coats Nitrile Exam Gloves
200pcs/box

Pamper your hands with Colloidal Oatmeal Active Therapeutic System. Recognised by FDA as a skin protectant, ideal if you suffer from dry hands. Latex-free and powder-free. See page 93 - 96 for our complete range of dental gloves.

Size	Code	Colour
XS	#990056a	
S	#990057a	Blue
M	#990058a	
L	#990059a	



\$0.99 /box

Safe Plus Face Mask
50pcs/box

Level 2 single use 3-ply ear loop face mask. Available in various colours. Latex-free, lint-free and fibreglass-free. Size: 175mm (L) x 90mm (W) See page 113 - 115 for our complete range of face masks.



Code	Colour
#992280a	Blue
#992281a	Pink
#992282a	Green
#992284a	White
#992285a	Purple
#992278a	Orange
#992279a	Teal



\$0.99 /box

Safe Plus NuFIT Face Mask, Anti-Fog
40pcs/box

Level 2 single use 3-ply ear loop face mask with enhanced NuFIT protection for a tight, custom fit. Anti-fog, latex-free, lint-free and fibreglass-free. Size: 175mm (L) x 90mm (W) See page 113 - 115 for our complete range of face masks.



Code	Colour
#992288a	Blue
#992289a	Pink



\$0.99 /box

Aloe Care Latex Exam Gloves
100pcs/box

Pamper your hands with Aloe Vera coated latex exam gloves to keep your hands soft and smooth all day long! Non-sterile, powder-free, full-textured and ambidextrous latex exam gloves. See page 93 - 96 for our complete range of dental gloves.

Size	Code	Colour
XS	#990040a	
S	#990041a	Natural Latex
M	#990042a	
L	#990043a	



\$0.99 /box

Ebony Face Mask
40pcs/box

Level 3 single use 4-ply ear loop black face mask. Latex-free, lint-free and fibreglass-free. Size: 175mm (L) x 90mm (W). See page 113 - 115 for our complete range of face masks.



Code	Colour
#992263a	Black



\$0.99 /bag

Saliva Ejectors
100pcs/bag

Disposable saliva ejectors for high volume evacuation of saliva and water from the oral cavity. Bendable with non-removable tips. Size: 150mm (L) x 6.5mm (Diameter) See page 65 - 70 for our complete range of evacuation products.

Code	Colour
#991240a	Assorted, Clear
#991241a	Blue Tip, Clear
#991242a	White Tip, Clear
#991243a	White Tip, White



\$0.99 /bag

Disposable HVE Tips, Assorted
100pcs/bag

Disposable vented HVE tips designed with unique 'S' tip and non-sharp edges for superior comfort. Each bag comes in assorted colours of purple, yellow, lime, blue and pink. Size: 145mm (L) x 11mm (Diameter) See page 65 - 70 for our complete range of evacuation products.

Code	Colour
#991233a	Assorted



\$33.55 each

Anaesthetics Cartridge Holder

Special Buy 4 @ \$30.45 each

Holds 50 1.8ml anaesthetics cartridges.
 Size: 89mm (Diameter) x 76mm (H)
 Code Colour
 #993830 Clear
 Cleaning instructions:
 Use only soap and water on acrylic surface. Alcohol or ammonia-based disinfectants may cause cracks to appear.



\$39.15 each

Needle Station

Special Buy 4 @ \$35.55 each

Holds any dental needle sheath.
 Made of stainless steel with silicone non-slip ring base and fully autoclavable up to 135°C.
 Size: 50mm (Diameter) x 38mm (H)
 Code Colour
 #993831 Clear



\$10.95 /box

Needle Sheath Prop

Special Buy 4 @ \$9.65/box

100pcs/box

A disposable needle recapping device that can be used to safely uncap and recap needles.
 Size: 70mm (L) x 70mm (H)
 Code Colour
 #993832 White/Red



Articulating Paper, Horseshoe

Easily obtain accurate pressure distribution within seconds. High spots are immediately visible.

Size	Quantity	Regular Price	Special Price	Code	Colour
100 microns	20pcs/book, 6 books/box	\$17.95/box	Buy 4 @ \$16.35/box	#993080	Red
100 microns	12pcs/book, 6 books/box	\$17.95/box	Buy 4 @ \$16.35/box	#993085	Blue/Pink



Articulating Paper, Booklet

Easily obtain accurate pressure distribution within seconds. High spots are immediately visible.

Size	Quantity	Regular Price	Special Price	Code	Colour
100 microns	20pcs/book, 10 books/box	\$6.55/box	Buy 4 @ \$5.95/box	#993083	Blue
100 microns	12pcs/book, 12 books/box	\$6.55/box	Buy 4 @ \$5.95/box	#993084	Blue/Red
50 microns	20pcs/book, 10 books/box	\$6.55/box	Buy 4 @ \$5.95/box	#993082	Blue
30 microns	20pcs/book, 10 books/box	\$6.55/box	Buy 4 @ \$5.95/box	#993081	Red



DENTAL DIAMOND BURS



PAGE 8 - 15

Directions of use:

- Note: NuMedical Dental Diamond Burs are non-sterile and are manufactured for dental use only.
1. The device is to be used on the instruction of, or by a dentist or other licensed practitioner.
 2. Clean and sterilise non-sterile burs in accordance with the validated procedure prior to first use and prior to each reuse.
 3. Do not force bur into the handpiece. In case of difficult access, check both handpiece turbine and bur and refer to handpiece instructions for troubleshooting.
 4. Do not use worn-out or dull burs.
 5. Do not apply excessive pressure on the bur as this could cause undesirable heat or may cause the bur to fail.
 6. Avoid removing the bur at too sharp an angle to avoid leverage and breakage.
 7. Carefully read package labels to ensure use of the appropriate device.
 8. Move the bur continuously when in use to avoid localised heating and/or damage to the bur.
 9. Maintain handpieces in good working condition to ensure maximum effectiveness of the device.
 10. Ensure the bur is fully seated and securely gripped in the handpiece collet prior to use.
 11. Always wear gloves when handling contaminated instruments. Refer to page 93 - 96 for gloves.
 12. Eye protection must be worn to protect against eject particles. Refer to page 111 - 112 for eye wear.
 13. Surgical masks must be worn to avoid inhalation of any aerosol or dust generated by the device. Refer to page 113 - 115 for masks.

Taper Flat End

Special Buy 4 @ \$9.65/pack
10pcs/pack

\$11.95 /pack

ISO	Head Size	Head Length	Total Length	Actual Length				Image
				Coarse	Fine	Extra Fine	Standard	
169/011	11	4	16.5				#994619	
169/011	11	4	19				#994495	
170/012	12	4	19				#994496	
170/014	14	4.5	19				#994497	
170/016	16	4.5	14.5				#994660	
170/016	16	4.5	17				#994618	
170/016	16	4.5	19	#994682			#994494	
170/023	23	4.5	20	#994683				
170/018	18	5	17				#994616	
170/018	18	5	19				#994492	
170/021	21	5.5	17				#994615	
170/021	21	5.5	19				#994491	
171/016	16	7	19				#994614	
171/016	16	7	21		#994730	#994776	#994490	
171/014	14	7	19				#994613	
171/014	14	7	21				#994489	
198/012	12	8	18				#994617	
198/012	12	8	20				#994493	
172/012	12	8	18				#994611	
172/012	12	8	20				#994487	
172/013	13	8	16.5				#994612	
172/013	13	8	20	#994681			#994488	
172/023	23	10	22				#994483	
172/023	23	10	24				#994666	
173/014	14	10	22				#994608	
173/014	14	10	24	#994676			#994480	
173/016	16	10	20				#994609	
173/016	16	10	22	#994677	#994729	#994775	#994481	
173/016	16	10	24				#994665	
173/018	18	10	22.5				#994486	
173/019	19	10	22.5	#994679			#994484	
173/017	17	10.3	22	#994680			#994485	
173/018	18	10.5	20				#994610	
173/018	18	10.5	22	#994678			#994482	

BURS AND ACCESSORIES

BURS AND ACCESSORIES



BURS AND ACCESSORIES

BURS AND ACCESSORIES

Taper Round End

Special Buy 4 @ \$9.65/pack
10pcs/pack

\$11.95 /pack

ISO	Head Size	Head Length	Total Length	Coarse	Fine	Extra Fine	Standard	Actual Length								
								0	5	10	15	20		25		
197/018	18	7	20	#994689												
197/014	14	7	21				#994505									
197/016	16	7	18				#994661									
197/016	16	7	19				#994623									
197/016	16	7	21		#994733	#994779	#994506									
197/018	18	7	21				#994509									
198/012	12	7.5	17				#994625									
198/012	12	7.5	19				#994508									
198/011	11	8	18				#994624									
198/011	11	8	20				#994507									
198/018	18	8	21				#994503									
198/013	13	8	17				#994626									
198/013	13	8	21				#994512									
199/018	18	8.5	21.5	#994688	#994735	#994781	#994511									
198/014	14	9	20				#994627									
198/014	016	9	22				#994513									
198/022	22	9.5	19.5	#994727												
198/022	22	9.5	21.5	#994687												
198/022	22	9.5	22				#994501									
198/022	22	9.5	23.5				#994668									
198/018	18	9.5	21				#994622									
198/018	018	9.5	22	#994686	#994732	#994778	#994500									
199/014	14	10	20				#994620									
199/014	14	10	22	#994684	#994731	#994777	#994498									
199/016	16	10	20				#994621									
199/016	16	10	22	#994685			#994499									
199/016	16	10	24				#994667									
199/016	16	10	21.5		#994734	#994780	#994510									
200/022	22	11.5	24				#994502									
200/024	24	11.5	23.5				#994504									

Chamfur

Special Buy 4 @ \$9.65/pack
10pcs/pack

\$11.95 /pack

ISO	Head Size	Head Length	Total Length	Coarse	Fine	Extra Fine	Standard	Actual Length								
								0	5	10	15	20		25		
197/015	15	6.5	15.5				#994664									
197/015	15	6.5	17.5				#994657									
297/015	15	6.5	19.5				#994603									
299/017	17	6.5	17				#994658									
299/017	17	6.5	19				#994604									
298/018	18	8	19.5				#994659									
298/018	18	8	21.5	#994725	#994772		#994605									
298/018	18	8	23.5				#994673									
198/011	11	8	17				#994656									
198/011	11	8	19	#994723	#994770		#994601									
298/015	15	8.5	21.5	#994715	#994768		#994597									
298/019	19	8.5	20	#994726	#994773		#994606									
298/019	19	8.5	22				#994674									
198/010	10	8.5	21	#994713	#994766		#994594									
299/017	17	9.5	21	#994724	#994771	#994784	#994602									
299/021	21	9.5	23				#994607									
299/021	21	9.5	25				#994675									
298/017	17	10	21				#994598									
198/013	13	10	21				#994595									
198/014	14	10	22	#994714	#994767		#994596									
298/016	16	10	22	#994722	#994769		#994599									
198/019	19	12	24				#994600									
198/018	18	12	26				#994672									

Taper Cone Tip

Special Buy 4 @ \$9.65/pack
10pcs/pack

\$11.95 /pack

ISO	Head Size	Head Length	Total Length	Coarse	Fine	Extra Fine	Standard	Actual Length								
								0	5	10	15	20		25		
160/012	22	6	21				#994520									
166/011	11	8	17				#994629									
166/011	11	8	20				#994518									
160/014	14	8	20	#994728			#994630									
160/014	14	8	22		#994737	#994783	#994519									
166/011	11	10	22				#994516									
160/016	16	10	20				#994628									
160/016	16	10	22	#994690	#994736	#994782	#994517									
166/019	19	13	25				#994669									

Straight Round End

Special Buy 4 @ \$9.65/pack
10pcs/pack

\$11.95 /pack

ISO	Head Size	Head Length	Total Length	Coarse	Fine	Extra Fine	Standard	Actual Length								
								0	5	10	15	20		25		
140/012	12	6	21.5	#994720	#994751		#994552									
140/014	14	6	22	#994721			#994553									
141/010	10	8	22		#994746		#994548									
141/012	12	8	22	#994716	#994747	#994797	#994549									
141/016	16	8	22	#994718	#994749		#994551									
141/018	18	8	22	#994719	#994750											
141/014	14	8.5	22	#994717	#994748	#994798	#994550									

BURS AND ACCESSORIES

BURS AND ACCESSORIES

BURS AND ACCESSORIES

BURS AND ACCESSORIES

Straight Flat End

Special Buy 4 @ \$9.65/pack
10pcs/pack

\$11.95 /pack

ISO	Head Size	Head Length	Total Length	Actual Length				Image
				Coarse	Fine	Extra Fine	Standard	
107/008	8	4	16.5				#994636	
107/008	8	4	19.5				#994542	
109/010	10	4	17				#994637	
109/010	10	4	19	#994700			#994543	
107/014	14	4.5	17				#994635	
109/013	13	4.5	19				#994541	
111/012	12	6	19.5				#994540	
110/014	14	7	21	#994699			#994539	
111/012	12	8	20				#994633	
111/012	12	8	22	#994696			#994536	
111/014	14	8	19.5				#994634	
111/014	14	8	22	#994697			#994537	
111/014	14	8	24				#994671	
111/016	16	8	22	#994698			#994538	

Flame Ogival End

Special Buy 4 @ \$9.65/pack
10pcs/pack

\$11.95 /pack

ISO	Head Size	Head Length	Total Length	Actual Length				Image
				Coarse	Fine	Extra Fine	Standard	
257/018	18	3	19	#994693	#994740		#994533	
257/018	18	3.5	19.5	#994694				
257/018	18	4	19				#994534	
540/007	7	4	22			#994789		
540/009	9	4	22				#994535	
257/019	19	4.5	19.5			#994787	#994532	
243/010	10	4.5	23.5			#994790		
257/028	28	5	20				#994530	
257/028	28	5.1	19	#994691				
257/032	32	5	19				#994531	
257/021	21	5	19.5	#994692				
248/014	14	6	20			#994785		
248/012	12	6.5	19			#994791		
249/011	11	7	19.5				#994631	
249/011	11	7	21.5				#994525	
298/014	14	7	18				#994632	
298/014	14	7	21		#994738	#994786	#994527	
298/016	16	7	21		#994739	#994788	#994528	
249/013	13	8	21				#994526	
249/016	16	8	21				#994529	
248/012	12	8	22			#994792		
190/018	18	9.5	21	#994695				
299/012	12	10	24				#994521	
250/014	14	10	22				#994522	
250/017	17	10	22				#994523	
251/023	23	10	22				#994524	

Straight Ogival End

Special Buy 4 @ \$9.65/pack
10pcs/pack

\$11.95 /pack

ISO	Head Size	Head Length	Total Length	Actual Length				Image
				Coarse	Fine	Extra Fine	Standard	
288/012	12	6	16.5				#994662	
288/012	12	6	19				#994638	
288/012	12	6	21				#994545	
130/012	12	6	19				#994547	
289/014	14	8	21.5				#994546	
131/014	14	10	22				#994544	

Marginal Shaper

Special Buy 4 @ \$9.65/pack
10pcs/pack

\$11.95 /pack

ISO	Head Size	Head Length	Total Length	Actual Length				Image
				Coarse	Fine	Extra Fine	Standard	
299/016	16	8	19.5				#994514	
299/019	19	9	22.5				#994515	

Rounded Shoulder

Special Buy 4 @ \$9.65/pack
10pcs/pack

\$11.95 /pack

ISO	Head Size	Head Length	Total Length	Actual Length				Image
				Coarse	Fine	Extra Fine	Standard	
544/018	18	4.5	19				#994556	
545/018	18	7.5	21				#994555	
553/019	19	10.5	23				#994554	

NuMedical

Ball Round Type

Special Buy 4 @ \$9.65/pack
10pcs/pack

\$11.95 /pack

ISO	Head Size	Head Length	Total Length	Quality				Actual Length						Image				
				Coarse	Fine	Extra Fine	Standard	0	5	10	15	20	25					
001/006	6	0.6	19		#994744													
001/008	8	0.8	17						#994644									
001/008	8	0.8	19						#994575									
001/010	10	1.0	16.5						#994642									
001/010	10	1.0	19						#994573									
001/012	12	1.2	17						#994643									
001/012	12	1.2	19						#994574									
001/014	14	1.4	17						#994641									
001/014	14	1.4	19						#994572									
001/016	16	1.6	19						#994571									
001/014	14	1.4	19						#994794									
001/018	18	1.8	16.5						#994640									
001/018	18	1.8	19	#994706					#994570									
001/018	18	1.8	22						#994670									
001/023	23	2.3	19	#994705					#994569									

Wheel Round Edge

Special Buy 4 @ \$9.65/pack
10pcs/pack

\$11.95 /pack

ISO	Head Size	Head Length	Total Length	Quality				Actual Length						Image				
				Coarse	Fine	Extra Fine	Standard	0	5	10	15	20	25					
304/016	16	0.6	16.4		#994774													
304/016	16	0.6	19		#994745													
068/042	42	0.9	19						#994589									
068/042	42	1	19						#994592									
068/040	40	1.6	19	#994710					#994590									
068/042	42	2	19	#994711					#994591									
903/043	43	2.2	19.5	#994712					#994593									

Ball Collar Type

Special Buy 4 @ \$9.65/pack
10pcs/pack

\$11.95 /pack

ISO	Head Size	Head Length	Total Length	Quality				Actual Length						Image				
				Coarse	Fine	Extra Fine	Standard	0	5	10	15	20	25					
002/018	18	2.5	19				#994576											
002/014	14	2.5	16.5				#994647											
002/014	14	2.5	19				#994577											
002/012	12	3	16.5				#994648											
002/012	12	3	19				#994578											
002/010	10	3	17				#994645											
002/010	10	3	19				#994579											
002/012	12	3	17				#994646											
002/012	12	3	19				#994580											

Single Inverted Cone

Special Buy 4 @ \$9.65/pack
10pcs/pack

\$11.95 /pack

ISO	Head Size	Head Length	Total Length	Quality				Actual Length						Image				
				Coarse	Fine	Extra Fine	Standard	0	5	10	15	20	25					
010/010	10	1.6	16.5				#994652											
010/010	10	1.5	19.5				#994584											
010/012	12	1.5	16.5				#994653											
010/012	12	1.6	19.5				#994585											
010/014	14	1.8	17				#994654											
010/014	14	1.8	19	#994707			#994586											
010/016	16	1.8	16.5				#994655											
010/016	16	1.8	19	#994708			#994587											
010/023	23	2.5	19.5	#994709			#994588											

CR Type

Special Buy 4 @ \$9.65/pack
10pcs/pack

\$11.95 /pack

ISO	Head Size	Head Length	Total Length	Quality				Actual Length						Image				
				Coarse	Fine	Extra Fine	Standard	0	5	10	15	20	25					
196-015	15	4	19		#994753													
196-014	14	4	19			#994796												
196-020	20	6	20		#994752													
196-019	19	6	20			#994795												
197-012	12	7	21.5		#994754													
289-013	13	8	21.5		#994755													

Double Inverted Cone

Special Buy 4 @ \$9.65/pack
10pcs/pack

\$11.95 /pack

ISO	Head Size	Head Length	Total Length	Quality				Actual Length						Image				
				Coarse	Fine	Extra Fine	Standard	0	5	10	15	20	25					
019/010	10	2.3	14.5				#994663											
019/010	10	2.3	17				#994650											
019/010	10	2.3	19				#994582											
019/010	10	3	17.5				#994649											
019/010	10	3	19.5				#994581											
019/014	14	3.3	17				#994651											
019/014	14	3.3	19				#994583											

BURS AND ACCESSORIES

BURS AND ACCESSORIES

CD Type

Special Buy 4 @ \$9.65/pack
10pcs/pack

\$11.95 /pack

ISO	Head Size	Head Length	Total Length	Actual Length				Image
				Coarse	Fine	Extra Fine	Standard	
001-006	6	0.6	17					
254-009	9	1.2	17					
138-007	7	2.3	17					
161-007	7	2.5	16.5					
246-006	6	2.5	17					
246-007	7	2.5	16.5					
138-007	7	3.5	17					
108-008	8	3.5	16.5					
247-007	7	4	16.5					
171-013	13	6.5	16.5					



\$5.95 each

Small Round Bur Block - Magnetic

Special Buy 4 @ \$5.35 each

This magnetic round bur block provides easy storage for FG and RA burs. Holds up to 7 burs. Made from durable resin safe for autoclave machines. Autoclavable up to 135°C. Size: 41mm (Diameter)

Code	Colour
#993022	Yellow
#993023	Blue
#993024	Green
#993025	Pink
#993026	Purple

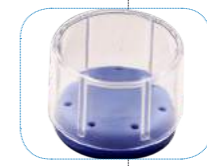

Small Round Bur Block Cover

Special Buy 4 @ \$1.65 each

Designed to fit the Small Round Bur Block (#993022 Series).
Cleaning instructions:
Wipe with alcohol-based disinfectant solution.

Code	Colour
#993037	Clear

\$1.85 each

Extra Special Shape

Special Buy 4 @ \$9.65/pack
10pcs/pack

\$11.95 /pack

ISO	Head Size	Head Length	Total Length	Actual Length				Image
				Coarse	Fine	Extra Fine	Standard	
150/010	10	0.4	21					
150/012	12	0.4	21					
237/010	10	3	19					
234/014	14	4.5	19					
038/043	43	4.5	19.5					
039/032	32	5	19					
237/018	18	5	16					
237/018	18	5	19					
237/012	12	5	19					
237/012	12	5.5	20					
237/012	12	5	22					
237/032	32	5	19					
655/016	16	7	20.5					
039/035	35	7	20					
002/018	18	7.5	19.5					
655/018	18	8	21.5					
234/021	21	8	20					
655/021	21	9	22.5					
220/017	17	10	24					

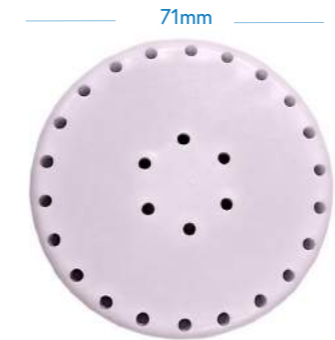

\$7.15 each

Large Round Bur Block - Magnetic

Special Buy 4 @ \$6.45 each

This magnetic round bur block provides easy storage for FG and RA burs. Holds up to 28 burs. Made from durable resin safe for autoclave machines. Autoclavable up to 135°C. Size: 71mm (Diameter)

Code	Colour
#993027	Yellow
#993028	Blue
#993029	Green
#993030	Pink
#993031	Purple

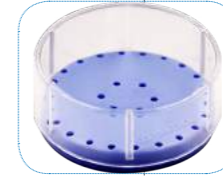

Large Round Bur Block Cover

Special Buy 4 @ \$1.65 each

Designed to fit the Large Round Bur Block (#993027 Series).
Cleaning instructions:
Wipe with alcohol-based disinfectant solution.

Code	Colour
#993038	Clear

\$1.85 each

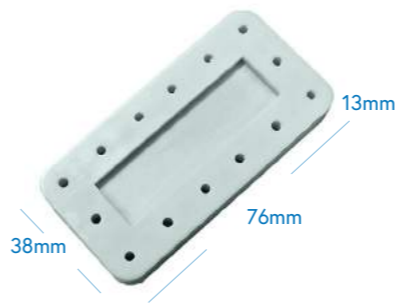

\$7.15 each

Rectangular Bur Block - Magnetic

Special Buy 4 @ \$6.45 each

This magnetic rectangular bur block provides easy storage for FG and RA burs. Holds up to 14 burs. Made from durable resin safe for autoclave machines. Autoclavable up to 135°C. Size: 76cm (L) x 38mm (W) x 13mm (H)

Code	Colour
#993032	Yellow
#993033	Blue
#993034	Green
#993035	Pink
#993036	Purple



Rectangular Bur Block Cover

Special Buy 4 @ \$1.65 each

Designed to fit the Large Rectangular Bur Block (#993032 Series).
Cleaning instructions:
Wipe with alcohol-based disinfectant solution.

Code	Colour
#993039	Clear

\$1.85 each

BURS AND ACCESSORIES

NuMedical

BURS AND ACCESSORIES

BURS AND ACCESSORIES

BURS AND ACCESSORIES

BURS AND ACCESSORIES

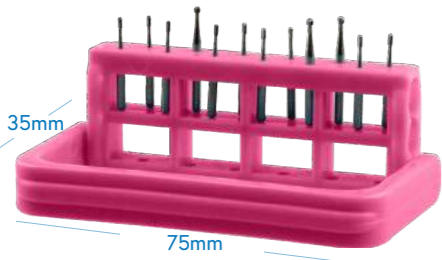

\$4.35 each

Burs not included.

Bur Caddy - 1

Special Buy 4 @ \$3.95 each

This bur caddy provides easy storage for FG and RA burs. Adjustable to three height levels and can hold up to 12 burs. Autoclavable up to 135°C. Size: 75mm (L) x 35mm (W)

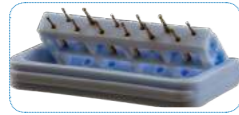

Code	Colour
#993060	Blue
#993061	Pink
#993062	Green
#993063	Yellow
#993064	Purple

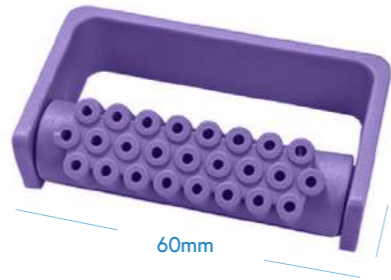

\$6.65 each

Bur Caddy - 2

Special Buy 4 @ \$6.05 each

This bur caddy provides easy storage for FG burs. Reversible and can hold up to 25 burs. Autoclavable up to 135°C. Size: 60mm (L) x 35mm (W)

Code	Colour
#994054	Blue
#994055	Red
#994056	Green
#994057	Yellow
#994058	Purple

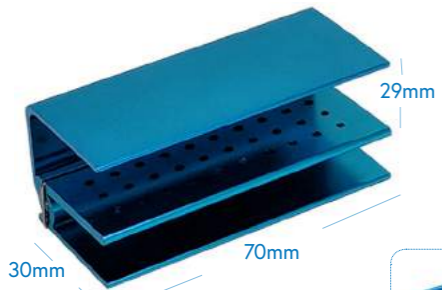

\$17.15 each

Aluminium FG Bur Block

Special Buy 4 @ \$15.55 each

This aluminium bur block provides easy storage for FG burs. It can hold up to 30 burs. Autoclavable up to 135°C. Size: 70mm (L) x 30mm (W) x 29mm (H)



Code	Colour
#993018	Blue



\$17.15 each

Aluminium FG and RA Bur Block

Special Buy 4 @ \$15.55 each

This aluminium bur block provides easy storage for FG and RA burs. It can hold up to 21 FG burs and 9 RA burs. Autoclavable up to 135°C. Size: 70mm (L) x 30mm (W) x 29mm (H)

Code	Colour
#993019	Blue

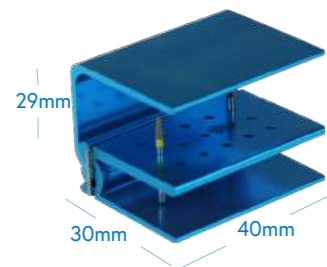

\$30.75 /box

Burs not included.

Aluminium Bur Block

Special Buy 4 @ \$27.95/box
2pcs/box

This aluminium bur block provides easy storage for FG burs. It can hold up to 15 burs. Autoclavable up to 135°C. Size: 40mm (L) x 30mm (W) x 29mm (H)

Code	Colour
#993017	Blue



\$14.55 /box

Large Bur Tray

Special Buy 4 @ \$13.15/box
5pcs/box

A tray for keeping burs and small hand instruments. Autoclavable up to 135°C. Size: 150mm (L) x 70mm (W) x 10mm (H)

Code	Colour
#993047	Silver

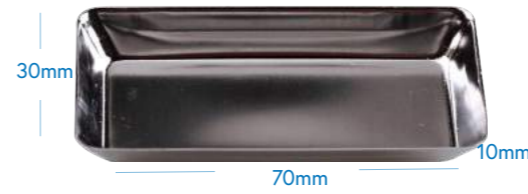

\$6.75 /box

Small Bur Tray

Special Buy 4 @ \$6.15/box
5pcs/box

A tray for keeping burs and small hand instruments. Autoclavable up to 135°C. Size: 70mm (L) x 30mm (W) x 10mm (H)

Code	Colour
#993048	Silver

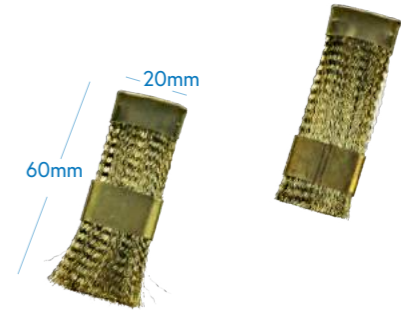

\$5.65 each

Wide Bur Brush

Special Buy 4 @ \$5.15 each

A simple bur-cleaning tool with brass wire bristles. Autoclavable up to 135°C. Size: 60mm (L) x 20mm (W)

Code	Colour
#993015	Gold



\$18.65 each

Brass Bur Brush

Special Buy 4 @ \$16.95 each

Bur brush with telescopic handle and brass wire bristles. Autoclavable up to 135°C. Size: 85mm (L)

Code	Colour
#993016	Brass

NuMedical

NuMedical

CHEEK RETRACTORS

CHEEK RETRACTORS

CHEEK RETRACTORS

CHEEK RETRACTORS



\$7.65 /box



Lip Ring Retractors

Special Buy 4 @ \$6.95/box
2pcs/box

Helps protect patient's lips during interproximal stripping. Made of high quality medical grade plastic. Autoclavable up to 135°C.

Size	Code	Colour
Adults	#992674	White
Kids	#992675	White



\$15.55 /box

Mouth Props

Special Buy 4 @ \$14.15/box
2pcs/box

Made of silicone. Latex-Free. Autoclavable up to 135°C.

Size	Code	Colour
Adults	#992671	Purple
Kids	#992672	Blue
Pedo	#992673	Yellow



\$6.95 /box

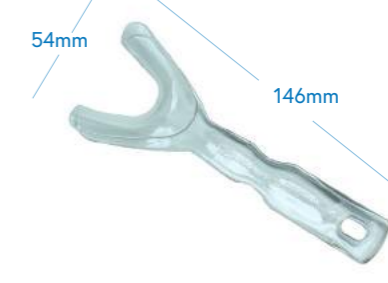

Photo Cheek Retractors - Long Handle

Special Buy 4 @ \$6.35/box
2pcs/box

Designed to fit most adults and children comfortably. Made of durable and lightweight plastic which is long-lasting and does not crack. Able to withstand repeated sterilisation. Provides a greater field of the posterior view. Autoclavable up to 135°C.

Size	Code	Colour
Adults	#992676	Blue Tint
Kids	#992677	Blue Tint



\$42.85 /box



Photo Cheek Retractors - Extra Long Handle

Special Buy 4 @ \$38.95/box
2pcs/box

Designed to fit most adults and children comfortably. Made of durable and lightweight plastic which is long-lasting and does not crack. Able to withstand repeated sterilisation. Provides a greater field of the posterior view. Autoclavable up to 135°C. Size: 146mm (L) x 54mm (W)

Size	Code	Colour
Uni	#992670	Blue Tint



\$6.95 /box



Photo Lip Retractors

Special Buy 4 @ \$6.35/box
2pcs/box

Easy grip handle with excellent anatomical fit and an angled bend to help retract patient's lips. Smooth rounded edge for comfort. One size fits all. Excellent for occlusal photographs. Autoclavable up to 135°C.

Size	Code	Colour
Uni	#992685	Blue Tint



\$6.95 /box



Photo Cheek Retractors - Double Ended

Special Buy 4 @ \$6.35/box
2pcs/box

Designed to fit most adults and children comfortably. Made of durable and lightweight plastic which is long-lasting and does not crack. Suitable for posterior photography. Autoclavable up to 135°C.

Size	Code	Colour
Uni	#992684	Blue Tint



\$6.95 /box

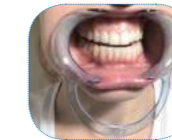

Extraoral Cheek Retractors

Special Buy 4 @ \$6.35/box
2pcs/box

Provides full anterior and posterior view for bonding. Does not reflect flash light. Autoclavable up to 135°C.

Size	Code	Colour
Adults	#992678	Blue Tint
Kids	#992679	Blue Tint
Pedo	#992680	Blue Tint



\$6.95 /box



Intraoral Cheek Retractors

Special Buy 4 @ \$6.35/box
2pcs/box

Recommended for bonding. Provides unrestricted access to the entire mouth. Autoclavable up to 135°C.

Size	Code	Colour
Adults	#992681	Blue Tint
Kids	#992682	Blue Tint
Pedo	#992683	Blue Tint

NuMedical



\$20.55 each

Face Mask Dispenser
Special Buy 4 @ \$18.65 each

Ideal for storing face masks. Pre-drilled holes for wall-mounting.
Size: 210mm (L) x 110mm (W) x 130mm (H)
Cleaning instructions:
Use only soap and water on acrylic surface. Alcohol or ammonia-based disinfectants may cause cracks to appear.

Code	Colour
#992371	Clear



\$20.55 each

Bib and Hand Towel Dispenser
Special Buy 4 @ \$18.65 each

Fits Hand Towels (#992702) and dental bibs with the dimensions 330mm (L) x 450mm (W). Dispenser Size: 180mm (L) x 130mm (W) x 150mm (H)
Cleaning instructions: Use only soap and water on acrylic surface. Alcohol or ammonia-based disinfectants may cause cracks to appear.

Code	Colour
#990260	Clear



\$2.95 /box

Instrument Code Ring (M)
Special Buy 6 @ \$2.35/box
25pcs/box

Made of pre-cut elastic silicone rubber which can be slipped onto instruments easily. Colour code your instruments according to procedures and surgeries. Autoclavable up to 135°C. Size: 6.5mm (Inner Diameter)

Code	Colour
#994030	Dark Blue
#994031	Light Blue
#994032	Red
#994033	Green
#994034	Yellow
#994035	White
#994036	Black
#994037	Purple



\$3.75 /box

Instrument Code Ring (S)
Special Buy 6 @ \$3.35/box
50pcs/box

Made of pre-cut elastic silicone rubber which can be slipped onto instruments easily. Colour code your instruments according to procedures and surgeries. Autoclavable up to 135°C. Size: 3.5mm (Inner Diameter)

Code	Colour
#994038	Dark Blue
#994039	Light Blue
#994040	Red
#994041	Green
#994042	Yellow
#994043	White
#994044	Black
#994045	Purple



\$6.55 each

Cotton Roll Dispenser
Special Buy 4 @ \$5.95 each

Top lid flips back to insert cotton rolls, drawer slides out to dispense up to 4 cotton rolls.
Size: 110mm (L) x 53mm (W) x 102mm (H)

Code	Colour
#992795	Blue
#992794	White

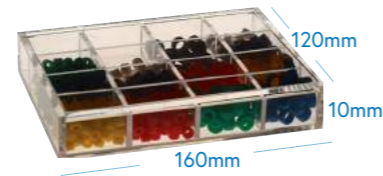

\$27.45 each

Instrument Code Ring Dispenser
Special Buy 4 @ \$24.95 each

Instrument code ring dispenser with 16 compartments.
Size: 160mm (L) x 120mm (W) x 10mm (H)
Cleaning instructions:
Use only soap and water on acrylic surface. Alcohol or ammonia-based disinfectants may cause cracks to appear.

Code	Colour
#993051	Clear



\$58.25 each

Benchtop Cabinet - 20 Drawers
Special Buy 4 @ \$52.95 each

Benchtop cabinet with 20 see-through drawers. Ideal for storing dental instruments and accessories.
Size: 380mm (L) x 150mm (W) x 190mm (H)
Cleaning instructions:
Wipe with alcohol-based disinfectant solution.

Code	Colour
#993481	Black
#993482	White



\$91.25 each

Benchtop Cabinet - 14 Drawers
Special Buy 4 @ \$82.95 each

Benchtop cabinet with 14 see-through drawers. Ideal for storing dental instruments and accessories.
Size: 450mm (L) x 180mm (W) x 250mm (H)
Cleaning instructions:
Wipe with alcohol-based disinfectant solution.

Code	Colour
#993483	Black
#993484	White



\$81.55 each

Sterilisation Pouch Dispenser

Ideal for storing sterilisation pouches of various sizes. Pre-drilled holes for wall-mounting.
Size: 750mm (L) x 90mm (W) x 345mm (H)
A: 57mm x 100mm (2 1/4" x 4")
B: 90mm x 230mm (3 1/2" x 9")
C: 90mm x 145mm (3 1/2" x 5 3/4")
D: 70mm x 230mm (2 3/4" x 9") and 90mm x 145mm (3 1/2" x 5 3/4")
E: 135mm x 260mm (5 1/4" x 10")
F: 190mm x 330mm (7 1/2" x 13")
Cleaning instructions:
Use only soap and water on acrylic surface. Alcohol or ammonia-based disinfectants may cause cracks to appear.

Code	Colour
#990640	Clear

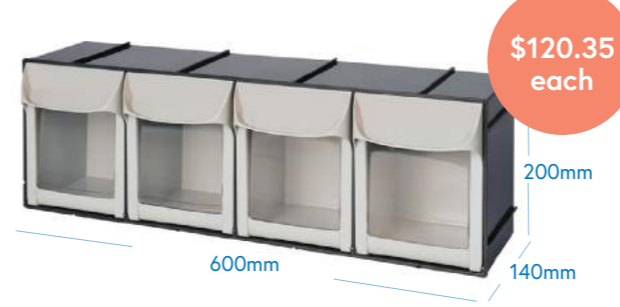

\$120.35 each

Tilt Bins - 4 Bins
Special Buy 4 @ \$109.35 each

Unique see-through 4-bin organisation system. Bins tilt out and stay open. Bins close easily with a touch of your finger. Ideal for storing dental instruments and accessories.
Size: 600mm (L) x 140mm (W) x 200mm (H)
Cleaning instructions:

Code	Colour
#993473	Black
#993474	White

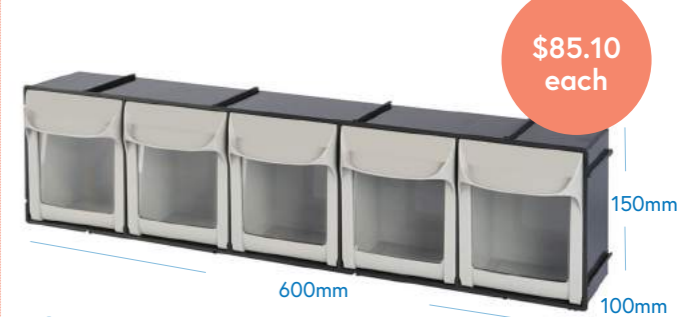

\$85.10 each

Tilt Bins - 5 Bins
Special Buy 4 @ \$77.35 each

Unique see-through 5-bin organisation system. Bins tilt out and stay open. Bins close easily with a touch of your finger. Ideal for storing dental instruments and accessories.
Size: 600mm (L) x 100mm (W) x 150mm (H)
Cleaning instructions:
Wipe with alcohol-based disinfectant solution.

Code	Colour
#993475	Black
#993476	White

CLINIC ORGANISERS

CLINIC ORGANISERS

CLINIC ORGANISERS

CLINIC ORGANISERS

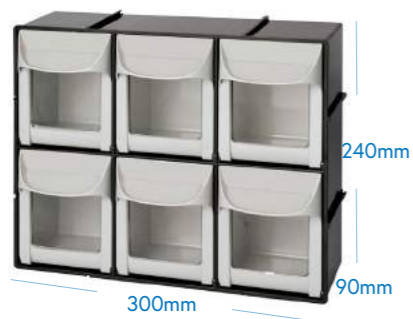

\$58.75 each

Tilt Bins - 6 Bins
Special Buy 4 @ \$53.45 each

Unique see-through 6-bin organisation system. Bins tilt out and stay open. Bins close easily with a touch of your finger. Ideal for storing dental instruments and accessories. Size: 300mm (L) x 90mm (W) x 240mm (H) *Cleaning instructions: Wipe with alcohol-based disinfectant solution.*



Code	Colour
#993477	Black
#993478	White



\$49.25 each

Tilt Bins - 8 Bins
Special Buy 4 @ \$44.75 each

Unique see-through 8-bin organisation system. Bins tilt out and stay open. Bins close easily with a touch of your finger. Ideal for storing dental instruments and accessories. Size: 300mm (L) x 70mm (W) x 200mm (H) *Cleaning instructions: Wipe with alcohol-based disinfectant solution.*



Code	Colour
#993479	Black
#993480	White

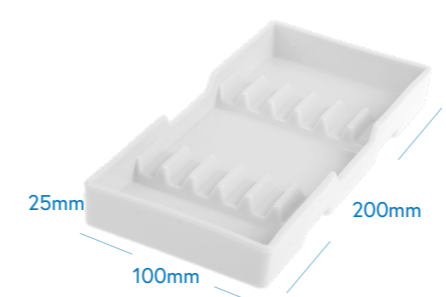

\$6.55 each

Drawer Organiser A
Special Buy 4 @ \$5.95 each

Designed for maximum convenience and efficiency. Easy to clean, sterilise and disinfect. Long-lasting, does not break or chip easily and chemical-resistant. Autoclavable up to 135°C. Size: 200mm (L) x 100mm (W) x 25mm (H)

Code	Colour
#993185	Blue
#993186	White

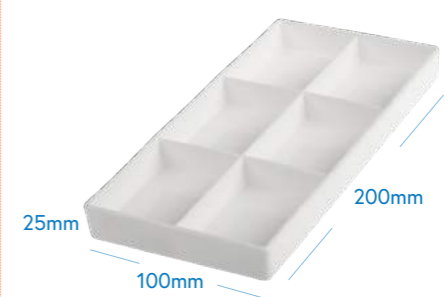

\$6.55 each

Drawer Organiser B
Special Buy 4 @ \$5.95 each

Designed for maximum convenience and efficiency. Easy to clean, sterilise and disinfect. Long-lasting, does not break or chip easily and chemical-resistant. Autoclavable up to 135°C. Size: 200mm (L) x 100mm (W) x 25mm (H)

Code	Colour
#993189	Blue
#993190	White



\$29.65 each

Gloves and Tissue Box Holder Type 1
Special Buy 4 @ \$26.95 each

Ideal for storing gloves or tissue. Pre-drilled holes for wall-mounting. Size: 250mm (L) x 110mm (W) x 125mm (H) *Cleaning instructions: Use only soap and water on acrylic surface. Alcohol or ammonia-based disinfectants may cause cracks to appear.*



Code	Colour
#990005	Clear

Fits our complete range of gloves. Pg 94 - 96

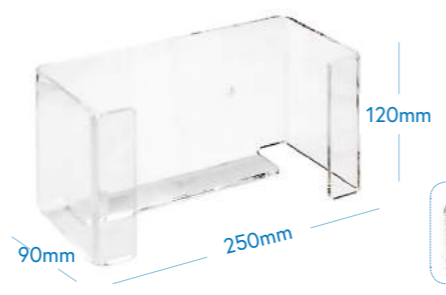

\$29.65 each

Gloves and Tissue Box Holder Type 2
Special Buy 4 @ \$26.95 each

Ideal for storing gloves or tissue. Pre-drilled holes for wall-mounting. Size: 250mm (L) x 90mm (W) x 120mm (H) *Cleaning instructions: Use only soap and water on acrylic surface. Alcohol or ammonia-based disinfectants may cause cracks to appear.*



Code	Colour
#990006	Clear

Fits all glove boxes except for Beesure Forest and Beesure Cloud. Pg 94 - 96

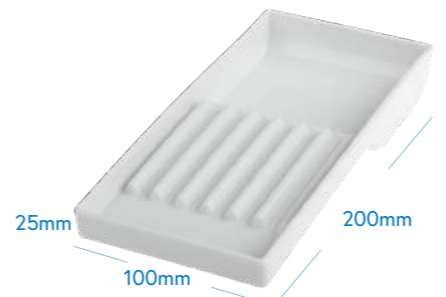

\$6.55 each

Drawer Organiser C
Special Buy 4 @ \$5.95 each

Designed for maximum convenience and efficiency. Easy to clean, sterilise and disinfect. Long-lasting, does not break or chip easily and chemical-resistant. Autoclavable up to 135°C. Size: 200mm (L) x 100mm (W) x 25mm (H)

Code	Colour
#993212	Blue
#993213	White

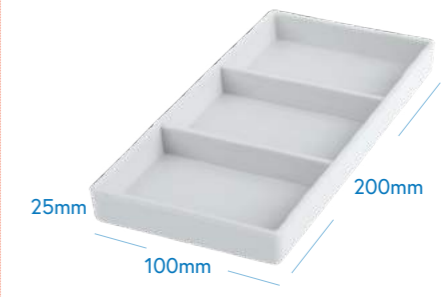

\$6.55 each

Drawer Organiser D
Special Buy 4 @ \$5.95 each

Designed for maximum convenience and efficiency. Easy to clean, sterilise and disinfect. Long-lasting, does not break or chip easily and chemical-resistant. Autoclavable up to 135°C. Size: 200mm (L) x 100mm (W) x 25mm (H)

Code	Colour
#993216	Blue
#993217	White



\$37.35 each

Gloves and Tissue Box Holder Type 3
Special Buy 4 @ \$33.95 each

Ideal for storing gloves or tissue. Pre-drilled holes for wall-mounting. Size: 250mm (L) x 90mm (W) x 250mm (H) *Cleaning instructions: Use only soap and water on acrylic surface. Alcohol or ammonia-based disinfectants may cause cracks to appear.*



Code	Colour
#990007	Clear

Fits all glove boxes except for Beesure Forest and Beesure Cloud. Pg 94 - 96



\$47.25 each

Gloves and Tissue Box Holder Type 4
Special Buy 4 @ \$42.95 each

Ideal for storing gloves or tissue. Pre-drilled holes for wall-mounting. Size: 250mm (L) x 90mm (W) x 370mm (H) *Cleaning instructions: Use only soap and water on acrylic surface. Alcohol or ammonia-based disinfectants may cause cracks to appear.*



Code	Colour
#990008	Clear

Fits all glove boxes except for Beesure Forest and Beesure Cloud. Pg 94 - 96



\$6.55 each

Drawer Organiser E
Special Buy 4 @ \$5.95 each

Designed for maximum convenience and efficiency. Easy to clean, sterilise and disinfect. Long-lasting, does not break or chip easily and chemical-resistant. Autoclavable up to 135°C. Size: 200mm (L) x 100mm (W) x 25mm (H)

Code	Colour
#993220	Blue
#993221	White

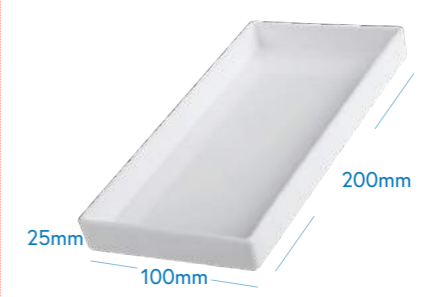

\$6.55 each

Drawer Organiser F
Special Buy 4 @ \$5.95 each

Designed for maximum convenience and efficiency. Easy to clean, sterilise and disinfect. Long-lasting, does not break or chip easily and chemical-resistant. Autoclavable up to 135°C. Size: 200mm (L) x 100mm (W) x 25mm (H)

Code	Colour
#993224	Blue
#993225	White

NuMedical

NuMedical



\$5.45 each

Mini Tray (Size F)

Special Buy 4 @ \$4.95 each

Ideal for exam or prophylaxis procedures. Autoclavable up to 135°C. Size: 245mm (L) x 167mm (W) x 22mm (H)

Code	Colour
#993150	Blue
#993151	Pink
#993152	Green
#993153	Yellow
#993154	Purple



\$5.45 each

Mini Tray Cover (Size F)

Special Buy 4 @ \$4.95 each

Highly durable, clear cover. Can double as a work surface or as a cover for the mini tray (size F).
Cleaning instructions: Wipe with alcohol-based disinfectant solution.

Code	Colour
#993205	Clear



\$59.95 each

Trays not included.

Mini Tray Rack - Holds Size F Trays

Made of sturdy chrome steel. Holds up to 6 mini trays (Size F) without covers. Size: 250mm (L) x 160mm (W) x 330mm (H)
Cleaning instructions: Wipe with alcohol-based disinfectant solution.

Code
#993165



\$80.95 each

Trays not included.

Flat Tray Rack - Holds Size B Trays (with covers)

Made of sturdy chrome steel. Holds up to 8 trays (size B) with covers. Size: 370mm (L) x 240mm (W) x 440mm (H)
Cleaning instructions: Wipe with alcohol-based disinfectant solution.

Code
#993166



\$8.15 each

Flat Tray (Size B)

Special Buy 4 @ \$7.35 each

These trays are the most versatile and popular amongst other setup trays. For maximum infection control, a flat tray setup with a separate sterilisable steri-mat and bur block is recommended. Autoclavable up to 135°C. Size: 343mm (L) x 245mm (W) x 22mm (H)

Code	Colour
#993155	Blue
#993156	Pink
#993157	Green
#993158	Yellow
#993159	Purple



\$8.15 each

Flat Tray Cover (Size B)

Special Buy 4 @ \$7.35 each

Highly durable, clear cover for the flat tray (Size B) that protects against airborne contaminants. Can also be used as a work surface.
Cleaning instructions: Wipe with alcohol-based disinfectant solution.

Code	Colour
#993204	Clear



\$80.95 each

Trays not included.

Flat Tray Rack - Holds Size B Trays (w/o covers)

Made of sturdy chrome steel. Holds up to 8 trays (size B) without covers. Size: 370mm (L) x 240mm (W) x 370mm (H)
Cleaning instructions: Wipe with alcohol-based disinfectant solution.

Code
#993174



\$16.90 each

Operation Tub

Special Buy 4 @ \$15.35 each

Made of sturdy plastic. Autoclavable/Chemicalable. Ideal for storing and transporting instruments and materials. Autoclavable up to 135°C. Size: 315mm (L) x 260mm (W) x 65mm (H)

Code	Colour
#993194	Blue
#993195	Pink
#993196	Green
#993197	Yellow
#993198	Purple



\$10.30 each

Flat Tray Divider (Size B)

Special Buy 4 @ \$9.35 each

A convenient setup tray to place instruments and accessories for different procedures. Autoclavable up to 135°C. Size: 343mm (L) x 245mm (W) x 22mm (H)

Code	Colour
#993160	Blue
#993161	Pink
#993162	Green
#993163	Yellow
#993164	Purple

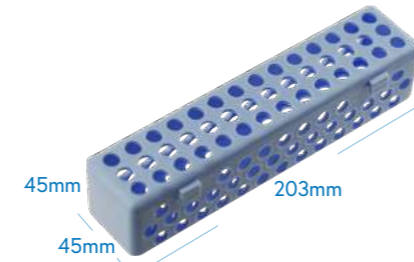

\$7.05 each

Steri-Cage

Special Buy 4 @ \$6.35 each

Economical container for sterilisation of individual instruments in ultrasonic cleaners and sterilisers. Autoclavable up to 135°C. Size: 203mm (L) x 45mm (W) x 45mm (H)

Code	Colour
#993169	Blue
#993170	Pink
#993171	Green
#993172	Yellow
#993173	Purple



\$8.10 each

Operation Tub Cover

Special Buy 4 @ \$7.35 each

Highly durable, clear cover for operation tub that protects against airborne contaminants. Able to store taller items. Can also be used to transport procedural items from the storage or sterilization area. Size: 245mm (L) x 167mm (W) x 22mm (H)
Cleaning instructions: Wipe with alcohol-based disinfectant solution.

Code	Colour
#993199	Clear

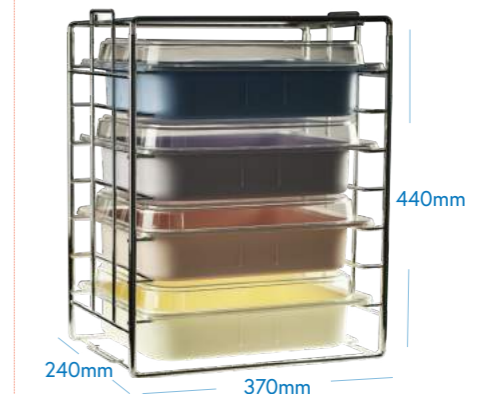

\$80.95 each

Operation Tubs not included.

Operation Tub Rack

Made of sturdy chrome steel Holds up to 4 operation tubs with covers. Size: 370mm (L) x 240mm (W) x 440mm (H)
Cleaning instructions: Wipe with alcohol-based disinfectant solution.

Code
#993203



Tub Divider
Special Buy 4 @ \$6.35/bag
 6pcs/bag

These 6 plastic tub dividers fit together to form compartments within the operation tub. They can be easily modified to suit individual clinical needs. Autoclavable up to 135°C. Size: 275mm (L) x 280mm (W)

Code	Colour
#993202	White

\$7.00 /bag



Tub Divider Insert
Special Buy 4 @ \$9.35 each

Made of sturdy plastic. Autoclavable/ Chemiclavable. Fits within the operation tub with 10 compartments. Autoclavable up to 135°C. Size: 285mm (L) x 229mm (W) x 28mm (H)

Code	Colour
#993200	White

\$10.00 each



Mini Aluminium Instrument Tray
Special Buy 4 @ \$13.95 each

Autoclavable up to 135°C. Size: 180mm (L) x 140mm (W) x 15mm (H)

Code	Colour
#992553	Silver
#992578	Blue
#992579	Yellow
#992580	Green
#992581	Red

\$15.35 each

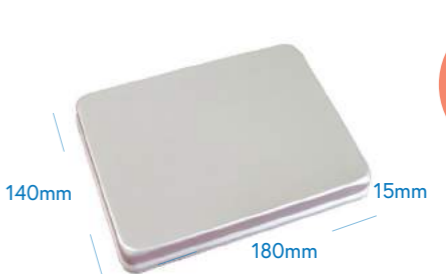

Mini Aluminium Instrument Tray Cover
Special Buy 4 @ \$13.95 each

Designed to fit the Mini Aluminium Instrument Tray. Autoclavable up to 135°C. Size: 180mm (L) x 140mm (W) x 15mm (H)

Code	Colour
#992554	Silver

\$15.35 each



Tub Accessory - Insert for Tub
Special Buy 4 @ \$3.95 each

Made of sturdy plastic. Autoclavable/ Chemiclavable. Fits within the operation tub. Autoclavable up to 135°C. Size: 245mm (L) x 130mm (W) x 25mm (H)

Code	Colour
#993201	White

\$4.35 each
 Operation Tub not included.



Disposable Mini Plastic Instrument Tray
Special Buy 4 @ \$9.90/bag
 100pcs/bag

Disposable single-use plastic trays. Ideal for procedural setups. Reduces the risk of cross contamination. Size: 180mm (L) x 140mm (W) x 15mm (H)

Code	Colour
#992548	White
#992549	Blue
#992550	Green
#992551	Yellow
#992552	Orange

\$10.90 /bag



Mini Instrument Tray Divider
Special Buy 4 @ \$9.95 each

Designed to fit within the Mini Aluminium Instrument Tray. Autoclavable up to 135°C. Size: 180mm (L) x 140mm (W) x 15mm (H)

Code	Colour
#992555	Silver

\$10.95 each



Standard Aluminium Instrument Tray
Special Buy 4 @ \$17.50 each

Autoclavable up to 135°C. Size: 280mm (L) x 180mm (W) x 15mm (H)

Code	Colour
#992542	Silver
#992533	Blue
#992534	Yellow
#992535	Green
#992536	Red

\$19.25 each



Disposable Standard Plastic Instrument Tray
Special Buy 4 @ \$10.60/bag
 100pcs/bag

Single-use plastic trays. Ideal for procedural setup. Reduces the risk of cross contamination. Size: 290mm (L) x 190mm (W) x 15mm (H)
Refer to page 45 - 55 for our complete range of disposable products.

Code	Colour
#992537	White
#992538	Blue
#992539	Green
#992540	Yellow
#992541	Orange

\$12.10 /bag



Plastic Instrument Tray
Special Buy 4 @ \$79.50/box
 10pcs/box

Used to keep instruments and procedural set-ups. Cleans easily and long-lasting. Size: 220mm (L) x 143mm (W) x 21mm (H)
Cleaning instructions:
 Wipe with alcohol-based disinfectant solution.

Code	Colour
#993191	Ivory

\$87.50 /box



Standard Aluminium Instrument Tray Cover
Special Buy 4 @ \$17.50 each

Designed to fit the Standard Aluminium Instrument Tray. Autoclavable up to 135°C. Size: 280mm (L) x 180mm (W) x 20mm (H)

Code	Colour
#992543	Silver

\$19.25 each



Standard Instrument Tray Divider
Special Buy 4 @ \$10.95 each

Designed to fit within the Standard Aluminium Instrument Tray. Autoclavable up to 135°C. Size: 280mm (L) x 180mm (W) x 20mm (H)

Code	Colour
#992544	Silver

\$12.05 each

CLINIC ORGANISERS

CLINIC ORGANISERS

CLINIC ORGANISERS

CLINIC ORGANISERS



\$125.00 each

Rotatable Unit Side Table

Special Buy 4 @ \$113.50 each

Save more space with this side table that can be rotated to 180°. It can be mounted to any unit. Ideal for placement of instruments, equipment or patient's belongings.
Size: 330mm (L) x 250mm (W) x 18mm (H)

Code	Colour
#993192	White

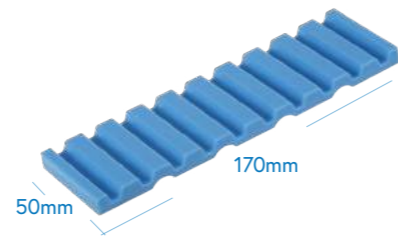

\$4.35 each

Instrument Mat

Special Buy 4 @ \$3.95 each

Made of medical grade silicone. Autoclavable up to 135°C.
Size: 170mm (L) x 50mm (W)

Code	Colour
#993206	Blue
#993207	Pink
#993208	Green
#993209	Yellow

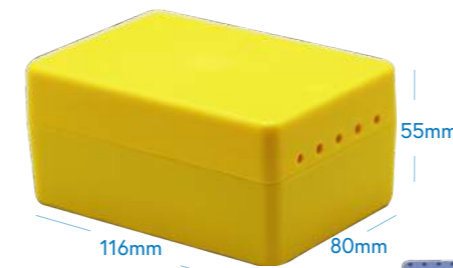

\$16.55 each

Jumbo Bur and Endo Steri Box

Special Buy 4 @ \$15.05 each

Designed for bur and endo instruments sterilisation. Capacity: 70pcs burs, 70pcs endo and 4 vials. Autoclavable up to 135°C.
Size: 116mm (L) x 80mm (W) x 55mm (H)

Code	Colour
#993498	Yellow

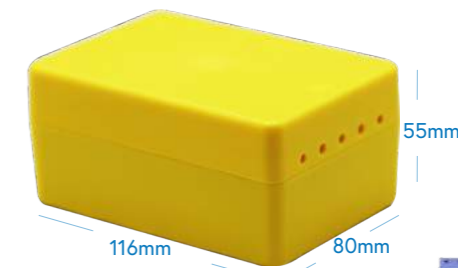

\$16.55 each

Jumbo Multi-Function Steri Box

Special Buy 4 @ \$15.05 each

Designed for multi-sterilisation. Capacity: 30pcs burs, 30pcs endo and 4 vials, 4 green implant holders and 4 blue small bur/parts holders. Autoclavable up to 135°C.
Size: 116mm (L) x 80mm (W) x 55mm (H)

Code	Colour
#993499	Yellow

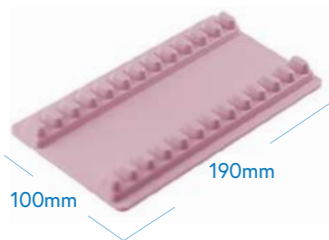

\$5.90 each

Large Instrument Mat

Special Buy 4 @ \$5.35 each

Capacity 12 pcs instruments. Autoclavable up to 135°C.
Size: 190mm (L) x 100mm (W)

Code	Colour
#993180	Blue
#993181	Pink
#993182	Green
#993183	Yellow
#993184	Purple

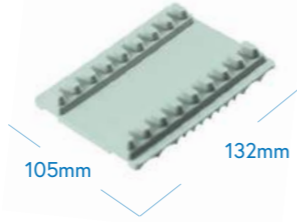

\$4.35 each

Small Instrument Mat

Special Buy 4 @ \$3.95 each

Capacity: 8 pcs instruments. Autoclavable up to 135°C.
Size: 132mm (L) x 105mm (W)

Code	Colour
#993175	Blue
#993176	Pink
#993177	Green
#993178	Yellow
#993179	Purple

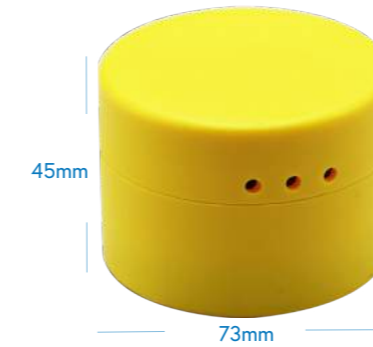

\$11.30 each

Large Round Steri Box - 16pcs

Special Buy 4 @ \$10.25 each

Designed for implants sterilisation. Capacity: 16pcs. Autoclavable up to 135°C.
Size: 73mm (Diameter) x 45mm (H)

Code	Colour
#993492	Yellow



\$11.30 each

Small Round Steri Box - 6pcs

Special Buy 4 @ \$10.25 each

Designed for implants sterilisation. Capacity: 6pcs. Autoclavable up to 135°C.
Size: 48mm (Diameter) x 54mm (H)

Code	Colour
#993493	Yellow

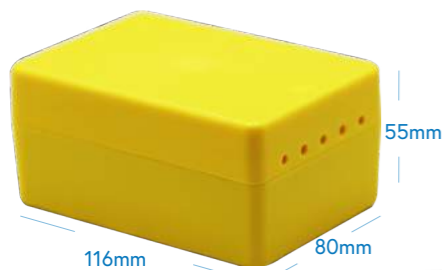

\$16.55 each

Jumbo Bur Steri Box

Special Buy 4 @ \$15.05 each

Designed for FG bur sterilisation. Capacity: 160pcs. Autoclavable up to 135°C.
Size: 116mm (L) x 80mm (W) x 55mm (H)

Code	Colour
#993496	Yellow

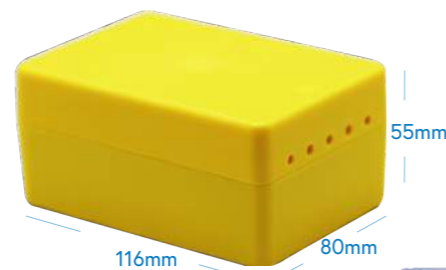

\$16.55 each

Jumbo Endo Steri Box

Special Buy 4 @ \$15.05 each

Designed for sterilisation of endo instruments. Capacity: 144pcs. Autoclavable up to 135°C.
Size: 116mm (L) x 80mm (W) x 55mm (H)

Code	Colour
#993497	Yellow

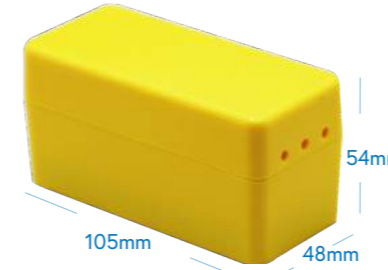

\$11.30 each

Rectangular Steri Box - 20pcs

Special Buy 4 @ \$10.25 each

Designed for implants sterilisation. Capacity: 20pcs. Autoclavable up to 135°C.
Size: 105mm (L) x 48mm (W) x 57mm (H)

Code	Colour
#993494	Yellow



\$11.30 each

Rectangular Steri Box - 10pcs

Special Buy 4 @ \$10.25 each

Designed for implants sterilisation. Capacity: 10pcs. Autoclavable up to 135°C.
Size: 59mm (L) x 48mm (W) x 54mm (H)

Code	Colour
#993495	Yellow

NuMedical

NuMedical

CLINIC ORGANISERS

CLINIC ORGANISERS

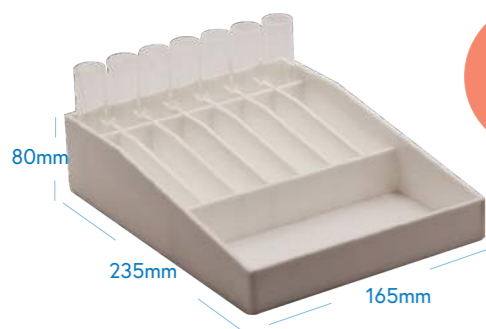

\$41.75 each

Instrument and Accessories Organiser

Special Buy 4 @ \$37.95 each

Size: 235mm (L) x 165 (W) x 80mm (H)
 Cleaning instructions:
 Use only soap and water on acrylic surface. Alcohol or ammonia-based disinfectants may cause cracks to appear.

Code	Colour
#993421	Clear



\$30.75 each

Covered Plier Organiser

Special Buy 4 @ \$27.95 each

Size: 185mm (L) x 150mm (W) x 190mm (H)
 Cleaning instructions:
 Use only soap and water on acrylic surface. Alcohol or ammonia-based disinfectants may cause cracks to appear.

Code	Colour
#993422	Clear

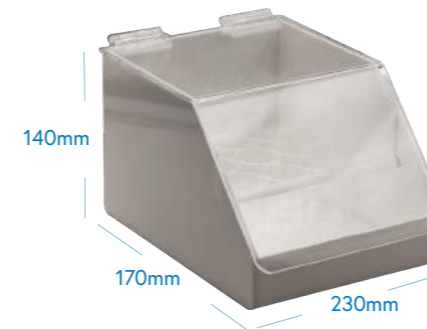

\$65.95 each

Power Stick and Chain Organiser

Special Buy 4 @ \$59.95 each

Size: 170mm (L) x 230mm (W) x 140mm (H)
 Cleaning instructions:
 Use only soap and water on acrylic surface. Alcohol or ammonia-based disinfectants may cause cracks to appear.

Code	Colour
#993427	Clear



\$32.95 each

Archwire Organiser - with lid

Special Buy 4 @ \$29.95 each

Size: 200mm (L) x 100mm (W) x 115mm (H)
 Cleaning instructions:
 Use only soap and water on acrylic surface. Alcohol or ammonia-based disinfectants may cause cracks to appear.

Code	Colour
#993428	Clear



\$16.45 each

Upright Plier Organiser

Special Buy 4 @ \$14.95 each

Size: 220mm (L) x 130mm (W) x 230mm (H)
 Cleaning instructions:
 Use only soap and water on acrylic surface. Alcohol or ammonia-based disinfectants may cause cracks to appear.

Code	Colour
#993423	Clear



\$30.75 each

Round Plier Organiser

Special Buy 4 @ \$27.95 each

Size: 100mm (H) x 100mm (Diameter)
 Cleaning instructions:
 Use only soap and water on acrylic surface. Alcohol or ammonia-based disinfectants may cause cracks to appear.

Code	Colour
#993424	Clear

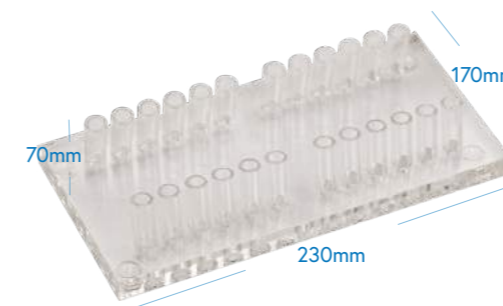

\$25.25 each

Archwire Organiser - without lid

Special Buy 4 @ \$22.95 each

Size: 230mm (L) x 170mm (W) x 70mm (H)
 Cleaning instructions:
 Use only soap and water on acrylic surface. Alcohol or ammonia-based disinfectants may cause cracks to appear.

Code	Colour
#993429	Clear



\$46.15 each

Bonding Pad Organiser

Special Buy 4 @ \$41.95 each

Size: 160mm (L) x 70mm (W) x 170mm (H)
 Cleaning instructions:
 Use only soap and water on acrylic surface. Alcohol or ammonia-based disinfectants may cause cracks to appear.

Code	Colour
#993434	Clear

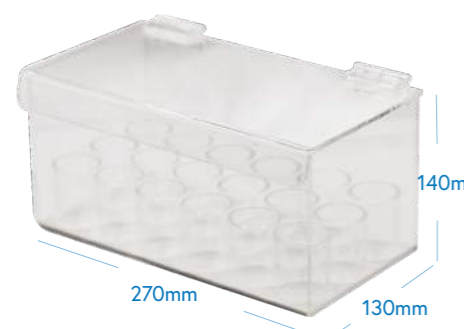

\$65.95 each

Power Stick Organiser

Special Buy 4 @ \$59.95 each

Size: 270mm (L) x 130mm (W) x 140mm (H)
 Cleaning instructions:
 Use only soap and water on acrylic surface. Alcohol or ammonia-based disinfectants may cause cracks to appear.

Code	Colour
#993425	Clear



\$30.75 each

Power Chain Organiser

Special Buy 4 @ \$27.95 each

Size: 250mm (L) x 100mm (W) x 110mm (H)
 Cleaning instructions:
 Use only soap and water on acrylic surface. Alcohol or ammonia-based disinfectants may cause cracks to appear.

Code	Colour
#993426	Clear

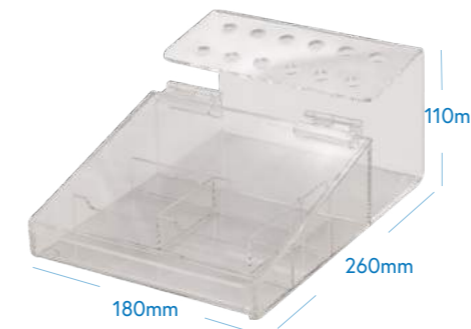

\$68.15 each

Adhesive Syringe Organiser

Special Buy 4 @ \$61.95 each

Size: 260mm (L) x 180mm (W) x 110mm (H)
 Cleaning instructions:
 Use only soap and water on acrylic surface. Alcohol or ammonia-based disinfectants may cause cracks to appear.

Code	Colour
#993436	Clear

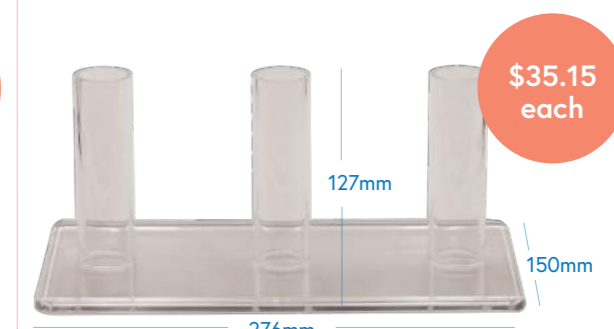

\$35.15 each

Straight Triple Impression Gun Holder

Special Buy 4 @ \$31.95 each

Stores up to 3 impression guns.
 Size: 276mm (L) x 150mm (W) x 127mm (H)
 Cleaning instructions:
 Use only soap and water on acrylic surface. Alcohol or ammonia-based disinfectants may cause cracks to appear.

Code	Colour
#991182	Clear

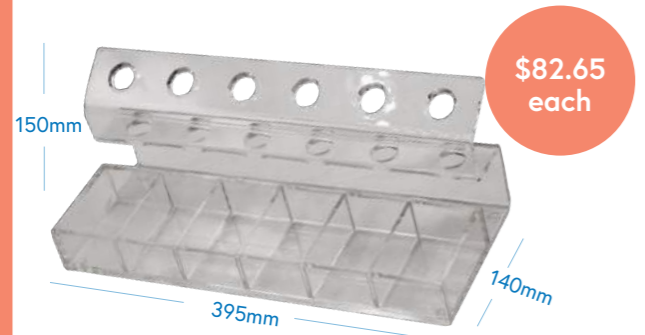

\$82.65 each

Acrylic Combination Organizer (6-Gun Holder)

Special Buy 4 @ \$75.15 each

Stores up to 6 impression guns with 6 additional compartments.
Size: 395mm (L) x 140mm (W) x 150mm (H)
Cleaning instructions:
Use only soap and water on acrylic surface. Alcohol or ammonia-based disinfectants may cause cracks to appear.

Code	Colour
#991177	Clear



\$51.95 each

Acrylic Combination Organizer (4-Gun Holder)

Special Buy 4 @ \$47.25 each

Stores up to 4 impression guns with 4 additional compartments.
Size: 265mm (L) x 140mm (W) x 150mm (H)
Cleaning instructions:
Use only soap and water on acrylic surface. Alcohol or ammonia-based disinfectants may cause cracks to appear.

Code	Colour
#991178	Clear

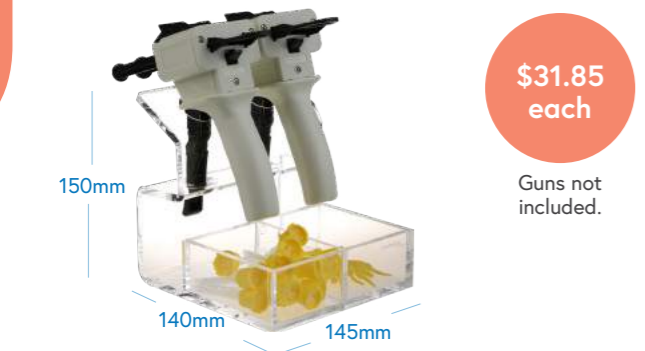

\$31.85 each
Guns not included.

Acrylic Combination Organizer (2-Gun Holder)

Special Buy 4 @ \$28.95 each

Stores up to 2 impression guns with 2 additional compartments.
Size: 145mm (L) x 140mm (W) x 150mm (H)
Cleaning instructions:
Use only soap and water on acrylic surface. Alcohol or ammonia-based disinfectants may cause cracks to appear.

Code	Colour
#991179	Clear



\$27.45 each
Guns not included.

Straight Dual Impression Gun Holder

Special Buy 4 @ \$24.95 each

This practical holder helps prevent clutter and stores two impression guns.
Size: 176mm (L) x 150mm (W) x 127mm (H)
Cleaning instructions:
Use only soap and water on acrylic surface. Alcohol or ammonia-based disinfectants may cause cracks to appear.

Code	Colour
#991180	Clear

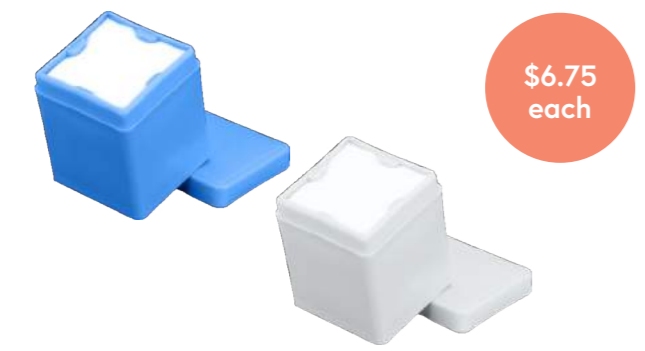

\$6.75 each

Sponge Dispenser

Special Buy 4 @ \$6.15 each

Suitable for 5cm x 5cm sponges. Autoclavable up to 135°C.

Code	Colour
#992831	Blue
#992832	White

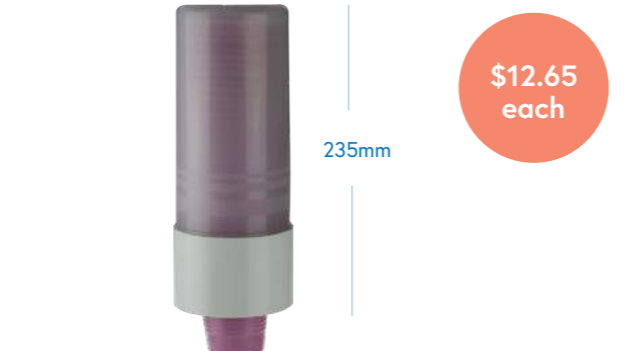

\$12.65 each

Plastic Cup Dispenser

Special Buy 4 @ \$11.55 each

Designed for 5 oz. plastic cups. See page 44 and 45 for 5 oz. plastic cup options.

Code	Colour
#990406	Clear



\$1,205.00 each

Metal Mobile Cabinet

Special Buy 2 @ \$1,095.00 each

The metal mobile cabinet is beautifully and ergonomically designed to provide ample storage space. It has 5 drawers and swivel wheels. Size: 510mm (L) x 490mm (W) x 790mm (H)

Code	Colour
#993461	Blue & White



\$319.00 each

Metal Mobile Cart

Special Buy 3 @ \$290.00 each

The metal mobile cart is fitted with 3 round-edged trays. The height between each tray is 300mm. Size: 490mm (L) x 400mm (W) x 850mm (H)

Code	Colour
#993460	White

COMPOSITE & CEMENT

COMPOSITE & CEMENT

COMPOSITE & CEMENT

COMPOSITE & CEMENT



\$12.05 /bottle

Mini Micro Applicators
Special Buy 4 @ \$10.95/bottle

FREE SAMPLES!

144pcs/bottle
Ideal for the application of bonding agents, etchants, hemostatic solutions, cavity liners and disclosing solutions. Non-absorbent, lint-free fibre. Single-use. 80mm (L)
Tip Size: 1.7mm - 1.8mm (Diameter)

Code	Colour
#990824	Blue
#990825	Yellow
#990826	Green
#990827	Red
#990828	Purple
#990829	Black



\$3.90 /bottle

FREE SAMPLES!

Micro Applicators, Regular
Special Buy 4 @ \$3.55/bottle

100pcs/bottle
Non-absorbent, lint-free fibre. Single-use. Size: 85mm (L)
Tip Size: 2.5mm (Diameter)

Code	Colour
#990800	Blue

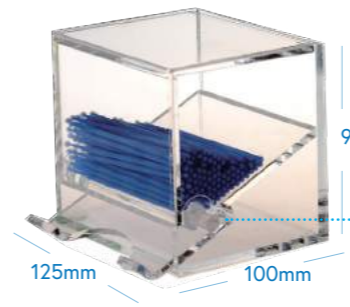

\$27.45 each

To release applicators, turn the handle clockwise as per indicated on the dispenser.

Micro Applicator Dispenser (One-Way)
Special Buy 4 @ \$24.95 each

Capacity: 400pcs
Size: 125mm (L) x 100mm (W) x 90mm (H)
Note: Does not fit Cylinder Micro Applicators (#990807).
Cleaning instructions:
Use only soap and water on acrylic surface. Alcohol or ammonia-based disinfectants may cause cracks to appear.

Code	Colour
#990808	Clear

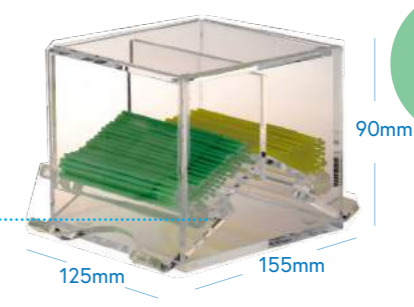

\$37.65 each

Micro Applicator Dispenser (Two-Way)
Special Buy 4 @ \$34.25 each

Capacity: 400pcs
Size: 125mm (L) x 155mm (W) x 90mm (H)
Note: Does not fit Cylinder Micro Applicators (#990807).
Cleaning instructions:
Use only soap and water on acrylic surface. Alcohol or ammonia-based disinfectants may cause cracks to appear.

Code	Colour
#990809	Clear



\$3.90 /bottle

FREE SAMPLES!

Micro Applicators, Fine
Special Buy 4 @ \$3.55/bottle

100pcs/bottle
Non-absorbent, lint-free fibre. Single-use. Size: 85mm (L)
Tip Size: 2.0mm (Diameter)

Code	Colour
#990802	Green



\$3.90 /bottle

FREE SAMPLES!

Micro Applicators, Ultra Fine
Special Buy 4 @ \$3.55/bottle

100pcs/bottle
Non-absorbent, lint-free fibre. Single-use. Size: 85mm (L)
Tip Size: 1.5mm (Diameter)

Code	Colour
#990804	Purple



\$0.85 each

Universal Brush Handle
Special Buy 4 @ \$0.75 each

Made of durable and lightweight plastic for repeated autoclaving. Suits all composite brushes and brush tips. Autoclavable up to 135°C. Single-use.

Code	Colour
#990838	White
#990839	Blue
#990840	Green
#990841	Red
#990844	Yellow



\$6.55 /bag

Brush Tips
Special Buy 4 @ \$5.95 bag

100pcs/bag
Tapered tip for smooth, even application of all types of liquid. Nylon bristle fits all leading brush handles. Single-use.

Code	Colour
#990842	Black Bristle



\$7.35 /bottle

FREE SAMPLES!

Micro Applicators, Cylinder
Special Buy 4 @ \$6.70/bottle

100pcs/bottle
Non-absorbent, lint-free fibre. Single-use. Size: 100mm (L)
Tip Size: 1.2mm (Diameter)

Code	Colour
#990807	Black



\$7.65 /bottle

FREE SAMPLES!

Brush Applicators
Special Buy 4 @ \$6.95/bottle

100pcs/bottle
Durable brush which can be bended to any angle. Easy to snap apart for lingual or interproximal use. Comes in assorted colours of blue, yellow, red and green. Single-use. Size: 100mm (L)

Code	Colour
#990816	Assorted



\$18.65 /box

Sticky Applicators
Special Buy 4 @ \$16.95/box

60pcs/box
Applicators designed for picking up small objects, colour-transfer and tissue-marking. Locating denture high spots just got easier. Unique, flexible dual-bend handle design to reach tight areas. Single-use.



Code	Colour
#990843	White

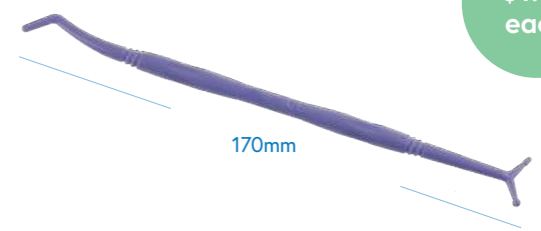

\$1.35 each

Cement Plugger
Special Buy 4 @ \$1.20 each

Cement plugger with double tips for convenience. Great for cleaning dental resin and filling different types of cavity. Autoclavable up to 135°C. Size: 170mm (L)

Code	Colour
#990792	Purple

NuMedical



Pre-Bent Dispensing Needle Tips

Special Buy 4 @ \$5.65/bag

100pcs/bag

Designed for placing etchants, sealants, cements and other flowable materials. Tips feature a blunt end and are pre-bent to the appropriate angle for convenience. Single-use.

Size	Code	Colour
19g (Composites, cements)	#990866	Black
18g (Cavity liners, bases, composites)	#990867	Pink
20g (Composites, cements)	#990868	Yellow
22g (Sealants, etchants, cements)	#990869	Grey
25g (Etchants)	#990870	Blue

\$6.25 /bag

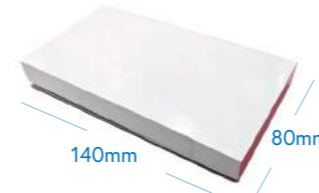
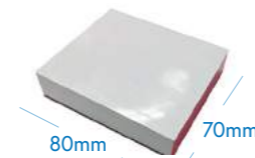
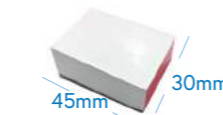

Mixing Pads - Paper + Poly

100pcs/book, 3 books/box

Poly-coated for superior performance. Single-use.

Size	Regular Price	Special Price	Code
45mm (L) x 35 mm (W)	\$4.90/box	Buy 4 @ \$4.45/box	#990851
80mm (L) x 70mm (W)	\$8.10/box	Buy 4 @ \$7.35/box	#990852
140mm (L) x 80mm (W)	\$10.95/box	Buy 4 @ \$9.95/box	#990854

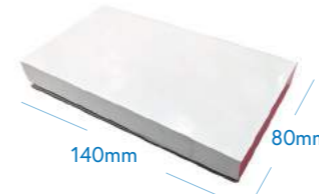
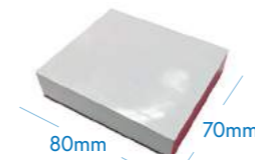

Non-Skid Mixing Pads - Paper + Poly

100pcs/book, 3 books/box

Poly-coated and non-skid poly-laminated to prevent slipping. Single-use.

Size	Regular Price	Special Price	Code
80mm (L) x 70mm (W)	\$8.75/box	Buy 4 @ \$7.95/box	#990853
140mm (L) x 80mm (W)	\$12.50/box	Buy 4 @ \$11.35/box	#990855

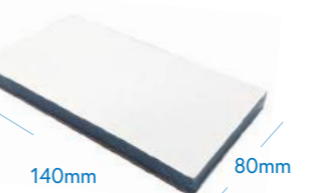
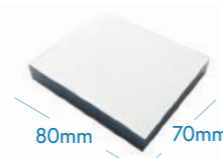

Mixing Pads - Plastic

100pcs/book, 3 books/box

These pads are made of plastic-coated special paper, which can be easily detached from the pad. Single-use.

Size	Regular Price	Special Price	Code
80mm (L) x 70mm (W)	\$8.75/box	Buy 4 @ \$7.95/box	#990856
140mm (L) x 80mm (W)	\$12.50/box	Buy 4 @ \$11.35/box	#990858

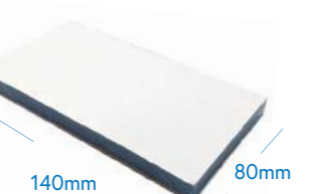
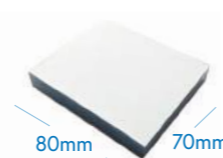

Non-Skid Mixing Pads - Plastic

100pcs/book, 3 books/box

Plastic-coated and non-skid poly-laminated to prevent slipping. Single-use.

Size	Regular Price	Special Price	Code
80mm (L) x 70mm (W)	\$10.30/box	Buy 4 @ \$9.35/box	#990857
140mm (L) x 80mm (W)	\$13.95/box	Buy 4 @ \$12.65/box	#990859



\$24.30 each

Carpules Dispenser Gun

Special Buy 4 @ \$22.10 each

Composite Dispensing Gun for capsules. Autoclavable up to 135°C.

Code	Colour
#990836	Blue
#990837	White



\$3.35 /box

Glass Dappen Dish

Special Buy 4 @ \$3.05/box

4pcs/box

Compatible with all dental materials. Size: 30mm (H) x 22mm (Diameter).
Cleaning instructions: Wipe with alcohol-based disinfectant solution.

Code	Colour
#990795	Assorted



\$2.75 /bag

Multi-Purpose Dappen Dish

Special Buy 4 @ \$2.50/bag

100pcs/bag

Suitable for prophylaxis, etchant and bonding. Single-use. Size: 21mm (H) x 20mm (Diameter).

Code	Colour
#990793	Assorted



\$7.00 each

Universal Materials Well

Special Buy 4 @ \$6.35 each

Suitable for prophylaxis, etchant and bonding with non-slip rubber base. Autoclavable up to 135°C. Size: 31mm (H) x 18mm (Diameter).

Code	Colour
#990887	Blue
#990888	Green
#990889	Orange
#990890	Purple
#990891	White



\$17.55 /box

Utility Syringe - Curved
Special Buy 4 @ \$15.95/box
 50pcs/box

Designed for surgical site and post-surgical home irrigation. Curved tip to reach tight areas. Can be used with silicone and rubber-based impression materials. Single-use.
 *1cc = 1ml

Size	Code
12cc	#991097



\$6.25 /bag

Mixing Wells - 2 Wells
Special Buy 4 @ \$5.65/bag
 200pcs/bag

Compatible with all dental materials. Easy to pick up. Single-use.
 Size: 52mm (L) x 28mm (W)

Code	Colour
#990790	White

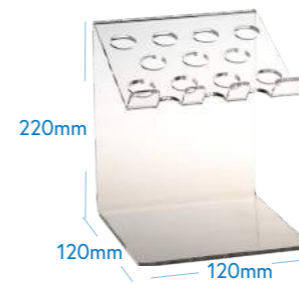

\$15.35 each

Small Composite Material Holder
Special Buy 4 @ \$13.95 each

11 holes. For storage of composites, adhesives, etc.
 Size: 120mm (L) x 120mm (W) x 220mm (H)
Cleaning instructions:
 Use only soap and water on acrylic surface. Alcohol or ammonia-based disinfectants may cause cracks to appear.

Code	Colour
#990832	Clear

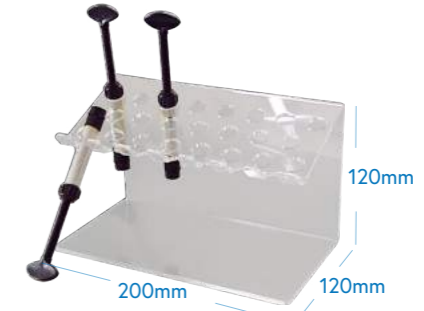

\$23.80 each

Large Composite Material Holder
Special Buy 4 @ \$21.65 each

23 holes. For storage of composites, adhesives, etc.
 Size: 200mm (L) x 120mm (W) x 120mm (H)
Cleaning instructions:
 Use only soap and water on acrylic surface. Alcohol or ammonia-based disinfectants may cause cracks to appear.

Code	Colour
#990833	Clear

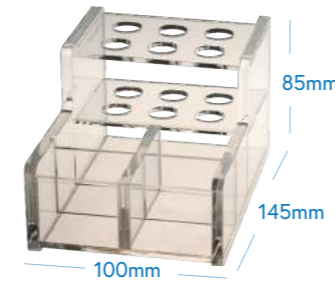

\$25.25 each

Mini Composite Syringe Organiser
Special Buy 4 @ \$22.95 each

6 holes. For storage of composites, adhesives, etc.
 Size: 100mm (L) x 145mm (W) x 85mm (H)
Cleaning instructions:
 Use only soap and water on acrylic surface. Alcohol or ammonia-based disinfectants may cause cracks to appear.

Code	Colour
#990830	Clear

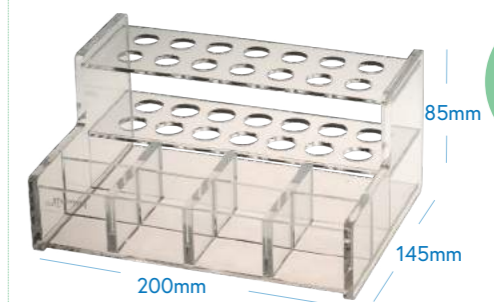

\$35.15 each

Composite Syringe Holder - 14
Special Buy 4 @ \$31.95 each

14 holes. For storage of composites, adhesives, etc.
 Size: 200mm (L) x 145mm (W) x 85mm (H)
Cleaning instructions:
 Use only soap and water on acrylic surface. Alcohol or ammonia-based disinfectants may cause cracks to appear.

Code	Colour
#990831	Clear



\$7.65 /bag

Mixing Wells - 4 Wells
Special Buy 4 @ \$6.95/bag
 200pcs/bag

Compatible with all dental materials. Easy to pick up. Single-use.
 Size: 52mm (L) x 52mm (W)

Code	Colour
#990791	White

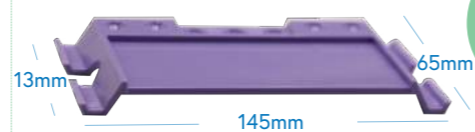

\$6.55 each

Mixing Stand
Special Buy 4 @ \$5.95 each

Ideal for mixing orthodontic cements, acid etching agents, composite resin and other dental materials. Mixing paper can also be placed on the mixing stand to mix special dental materials.
 Size: 145mm (L) x 65mm (W) x 13mm (H)

Code	Colour
#990796	Purple

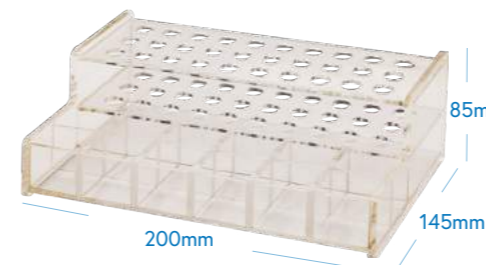

\$46.15 each

Composite Syringe Holder - 30
Special Buy 4 @ \$41.95 each

30 holes. For storage of composites, adhesives, etc.
 Size: 200mm (L) x 145mm (W) x 85mm (H)
Cleaning instructions:
 Use only soap and water on acrylic surface. Alcohol or ammonia-based disinfectants may cause cracks to appear.

Code	Colour
#990834	Clear



UV Cover

For protection of light-curing materials from ultraviolet light.
Cleaning instructions:
 Use only soap and water on acrylic surface. Alcohol or ammonia-based disinfectants may cause cracks to appear.

Size Options:
 Size 1: 100mm (L) x 75mm (W) x 30mm (H)
 Size 2: 150mm (L) x 100mm (W) x 30mm (H)

Size	Regular Price	Special Price	Code
1	\$10.30 each	Buy 4 @ \$9.35 each	#990876
2	\$12.50 each	Buy 4 @ \$11.35 each	#990877

Bib Colours and Prints:



\$3.05 /bag

FREE SAMPLES!

MUST BUY!

Junior Bibs, 2-Ply Tissue + Poly

Special Buy 4 @ \$2.75/bag

100pcs/bag

2-Ply tissue with poly-backing and vertical embossing. Optimal absorbency and barrier protection. Size: 220mm (L) x 330mm (W)

Code	Colour
#990202	White
#990203	Blue
#990204	Pink
#990205	Green
#990206	Yellow
#990207-1	Pink Zoe
#990207-2	Blue Zoe
#990201	Assorted

#990201 comes in assorted colours of Blue (20), Pink (20), Green (10), Yellow (10), Blue Zoe (20) and Pink Zoe (20) in a bag of 100pcs.

\$6.75 /bag

FREE SAMPLES!

Available in HOT & NEW Promo! (PG 1)

Patient Bibs, 2-Ply Heavy Tissue + Poly

Special Buy 4 @ \$6.15/bag

100pcs/bag

2-Ply heavy tissue patient bibs with poly-backing with vertical embossing. Optimal absorbency and barrier protection. Size: 330mm (L) x 450mm (W)

Code	Colour
#990210	Teal
#990211	Blue
#990212	Pink
#990213	Green
#990214	Purple
#990216	Yellow
#990217	White

20% HEAVIER THAN REGULAR 2+1 BIBS!

\$4.75 /bag

FREE SAMPLES!

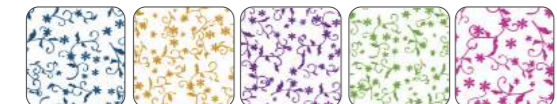

Floral Patient Bibs, 2-Ply Tissue + Poly

Special Buy 4 @ \$4.35/bag

100pcs/bag

2-Ply tissue with poly-backing and vertical embossing. Optimal absorbency and barrier protection. Size: 330mm (L) x 450mm (W)

Code	Colour
#990160-1	Blue
#990160-2	Yellow
#990160-3	Purple
#990160-4	Green
#990160-5	Pink

\$8.05 /bag

FREE SAMPLES!

Patient Bibs, 3-Ply Tissue + Poly

Special Buy 4 @ \$7.35/bag

100pcs/bag

3-Ply tissue patient bibs with poly-backing with vertical embossing. Optimal absorbency and barrier protection. Size: 330mm (L) x 450mm (W)

Code	Colour
#990180	White
#990181	Blue
#990182	Pink
#990183	Green
#990184	Yellow

\$4.75 /bag

FREE SAMPLES!

MUST BUY!

Patient Bibs, 2-Ply Tissue + Poly

Special Buy 4 @ \$4.35/bag

100pcs/bag

2-Ply tissue patient bibs with poly-backing and vertical embossing. Optimal absorbency and barrier protection. Available in various colours and prints! Size: 330mm (L) x 450mm (W)

Code	Colour	Code	Colour
#990151	Blue	#990158-1	Pink Zoe
#990152	Pink	#990158-2	Blue Zoe
#990153	Green	#990159	Trumpet Flower
#990156	Yellow	#990162	Polar Bear
#990157	White	#990163	Assorted Prints
#990161	Assorted		

#990161 comes in assorted colours of Blue (20), Pink (20), Green (20), Yellow (20) and White (20) in a bag of 100pcs.

#990163 comes in assorted prints of Floral Blue (10), Floral Pink (10), Floral Green (10), Floral Yellow (10), Floral Purple (10), Blue Zoe (10), Pink Zoe (10), Polar Bear (10) and Trumpet Flower (20) in a bag of 100 pcs.

\$18.60 /box

FREE SAMPLES!

Specialty Bibs, 3-Ply Tissue + Poly

Special Buy 4 @ \$16.90/box

100pcs/box

3-Ply tissue specialty bibs with poly-backing. Provides maximum absorbency for root canals, extractions and ultrasonic scaling. The neck contour provides a comfortable fit for patients. Size: 550mm (L) x 450mm (W)

Code	Colour
#990350	White
#990351	Blue
#990352	Pink
#990353	Green
#990354	Yellow

\$15.00 /box

FREE SAMPLES!

Specialty Bibs, 2-Ply Tissue + Poly

Special Buy 4 @ \$13.65/box

100pcs/box

2-Ply tissue specialty bibs with poly-backing. Provides maximum absorbency for root canals, extractions and ultrasonic scaling. The neck contour provides a comfortable fit for patients. Size: 460mm (L) x 450mm (W)

Code	Colour
#990355	White
#990356	Blue
#990357	Pink
#990358	Green
#990359	Yellow

\$28.55 /box

FREE SAMPLES!

Endo Bibs, Tissue + Poly + Tissue

Special Buy 4 @ \$25.95/box

100pcs/box

Waist-length endo bibs with neck contour. Provides maximum coverage and protection against fluids during endodontic and oral surgical procedures. Size: 720mm (L) x 530mm (W)

Code	Colour
#990339	White
#990340	Blue

DISPOSABLES

DISPOSABLES

NuMedical

NuMedical

DISPOSABLES

DISPOSABLES

NuMedical

NuMedical



\$25.65 /box

FREE SAMPLES!

Oral Surgery Bibs, Tissue + Poly + Tissue

Special Buy 4 @ \$23.35/box

50pcs/box
Knee-length endo bibs with neck contour. Provides maximum coverage and protection against fluids during endodontic and oral surgical procedures. Size: 1040mm (L) x 720mm (W)

Code	Colour
#990341	White
#990342	Blue



\$15.55 /box

FREE SAMPLES!

Self-Tape Patient Towels, Medium

Special Buy 4 @ \$14.15/box

100pcs/box

1-ply tissue with poly-backing and adhesive tab that eliminates the need for chains/clips. Simply position towel around the neck and apply pressure to the tab. Does not leave behind glue. Maximum infection control and patient comfort. Size: 560mm (L) x 430mm (W)

Code	Colour
#990248	Blue
#990249	Pink
#990250	Green
#990251	Yellow
#990252	White

Available in HOT & NEW Promo! (PG 1)

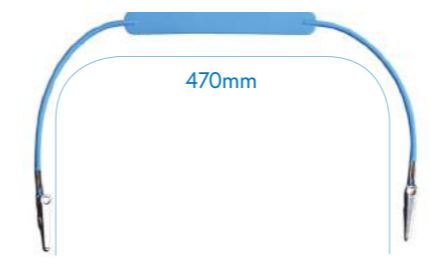

\$5.35 each

Silicone Dental Bib Clip - 470mm long

Special Buy 4 @ \$4.85 each

Made from medical grade silicone. Stainless steel aligator clips. Non-slip design. Autoclavable up to 135°C. Size: 470mm (L)

Code	Colour
#990262	Blue
#990263	Pink
#990264	Green
#990265	Yellow

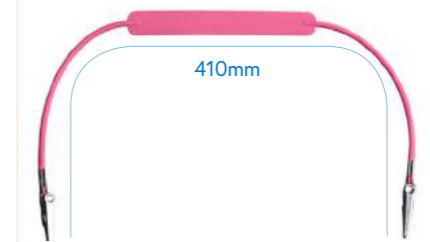

\$5.35 each

Silicone Dental Bib Clip - 410mm long

Special Buy 4 @ \$4.85 each

Made from medical grade silicone. Stainless steel aligator clips. Non-slip design. Autoclavable up to 135°C. Size: 410mm (L)

Code	Colour
#990271	Blue
#990272	Pink
#990273	Green
#990274	Yellow



\$15.20 /box

FREE SAMPLES!

Available in HOT & NEW Promo! (PG 1)

Self-Tape Patient Towels - Eco

Special Buy 4 @ \$13.80/box

100pcs/box
1-Ply tissue with poly-backing and adhesive tabs that eliminates the need for chains/clips. Simply position towel around the neck and apply pressure to the tab. Does not leave behind glue. Size: 560mm (L) x 430mm (W)

Code	Colour
#990256	Blue



\$11.30 /box

FREE SAMPLES!

Self-Tape Patient Towels, Large

Special Buy 4 @ \$10.25/box

50pcs/box

1-ply tissue with poly-backing and adhesive tab that eliminates the need for chains/clips. Simply position towel around the neck and apply pressure to the tab. Does not leave behind glue. Maximum infection control and patient comfort. Size: 650mm (L) x 560mm (W)

Code	Colour
#990253	Blue
#990254	White

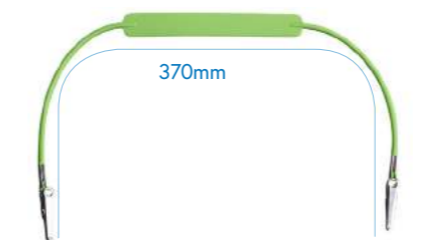

\$5.35 each

Silicone Dental Bib Clip - 370mm long

Special Buy 4 @ \$4.85 each

Made from medical grade silicone. Stainless steel aligator clips. Non-slip design. Autoclavable up to 135°C. Size: 370mm (L)

Code	Colour
#990281	Blue
#990282	Pink
#990283	Green
#990284	Yellow



\$2.15 each

Plastic Dental Bib Clip - 410mm long

Special Buy 4 @ \$1.95 each

Cold sterilisation only. Size: 410mm (L)

Code	Colour
#990296	Blue
#990297	Pink
#990298	Green
#990299	Yellow

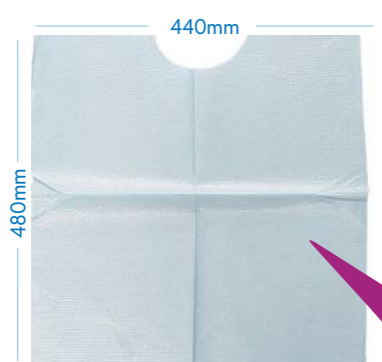

\$10.90 /box

FREE SAMPLES!

Available in HOT & NEW Promo! (PG 1)

Contour Patient Towels

Special Buy 4 @ \$9.90/box

100pcs/box
1-Ply tissue with poly-backing. The neck contour provides a comfortable fit for patients. Size: 480mm (L) x 440mm (W)

Code	Colour
#990255	Blue

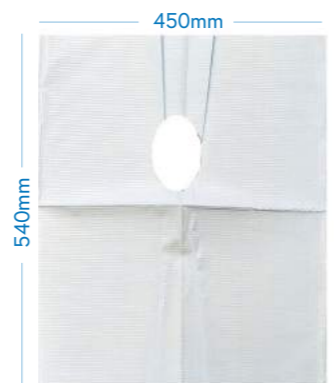

\$13.15 /box

FREE SAMPLES!

Dental Aprons with Hole, 2-Ply Tissue + Poly

Special Buy 4 @ \$11.95/box

100pcs/box

Provides maximum coverage and protection against fluids during examinations and dental surgeries. Size: 540mm (L) x 450mm (W)

Code	Colour
#990322	Blue



\$9.75 /box

FREE SAMPLES!

Bib Holders

Special Buy 4 @ \$8.85/box

250pcs/box

Made from lightweight and stretchable paper. These bib holders can be easily attached to bibs with easy-to-peel, adhesive ends. They can be thrown after each use to prevent cross contamination. Very comfortable, no sharp edges and can be stretched to suit different patients.

Code	Colour
#990294	White



\$2.15 /bag

FREE SAMPLES!

Clear Plastic Cups - 5oz (150ml)

Special Buy 4 @ \$1.95/bag

100pcs/bag

Made from a softer and thinner material. Embossed grip for greater strength and easy dispensing. Lustrous and high-gloss finish.

Code	Colour
#990482	Clear

Our plastic cups come in 16 different colours! Add some colour to your practice!



\$2.55 /bag

FREE SAMPLES!

MUST BUY!

Plastic Cups - 5 oz. (150ml)

Special Buy 4 @ \$2.35/bag
100pcs/bag

Embossed grip for greater strength and easy dispensing. Lustrous and high-gloss finish.

Code	Colour	Code	Colour
#990491	White	#990496	Red
#990485	Blue	#990502	Navy Blue
#990487	Green	#990501	Copper
#990498	Beige	#990490	Yellow
#990499	Gray	#990495	Navy Green
#990500	Plum	#990494	Orange
#990484	Teal	#990488	Purple
#990493	Dark Blue	#990486	Pink



\$2.55 /bag

FREE SAMPLES!

MUST BUY!

Plastic Cups - 7 oz. (210ml)

Special Buy 4 @ \$2.35/bag
100pcs/bag

Embossed grip for greater strength and easy dispensing. Lustrous and high-gloss finish.

Code	Colour	Code	Colour
#990539	White	#990544	Red
#990533	Blue	#990550	Navy Blue
#990535	Green	#990549	Copper
#990546	Beige	#990538	Yellow
#990547	Gray	#990543	Navy Green
#990548	Plum	#990542	Orange
#990532	Teal	#990536	Purple
#990541	Dark Blue	#990534	Pink

Paper Cups Prints:

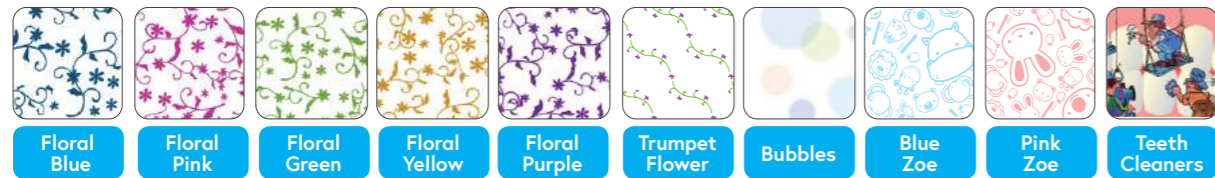

\$2.80 /bag

FREE SAMPLES!

MUST BUY!

Paper Cups - 5 oz. (150ml)

Special Buy 4 @ \$2.55/bag
100pcs/bag

Introducing our eco-friendly series of 5 oz. paper cups! NuMedical 5 oz. paper cups are made with less paper materials to conserve more natural resources! Each paper cup is made using 170g of food-grade paper and 12g of food-grade poly material. There are 9 different prints to choose from. Except for "Bubbles", all other prints match our dental bibs and face masks.

Code	Colour
#990444	Floral Blue
#990450	Floral Pink
#990451	Floral Green
#990452	Floral Yellow
#990453	Floral Purple
#990446	Bubbles
#990459	Trumpet Flower
#990445	Blue Zoe
#990454	Pink Zoe



\$3.80 /bag

FREE SAMPLES!

MUST BUY!

Paper Cups - 7 oz. (210ml)

Special Buy 4 @ \$3.45/bag
100pcs/bag

NuMedical 7 oz. paper cups are made using 210g of food-grade paper and 12g of food-grade poly material. There are 9 different prints to choose from. Except for "Teeth Cleaners", all other prints match our dental bibs and face masks.

Code	Colour
#990470	Floral Blue
#990471	Floral Pink
#990478	Floral Green
#990479	Floral Yellow
#990480	Floral Purple
#990464	Trumpet Flower
#990461	Blue Zoe
#990462	Pink Zoe
#990475	Teeth Cleaners



\$4.80 /bag

FREE SAMPLES!



Code	Colour
#990403	White

Cup Lids (5 oz. Paper Cups)

Special Buy 4 @ \$4.35/bag
100pcs/bag

An easy and hygienic way to dispose of used cotton balls, cotton rolls and applicators. Effectively reduces contaminants and fluids on tables and trays, keeping the area clean.



\$3.90 /box



Code	Colour
#990404	Clear

Cup Holders

Special Buy 4 @ \$3.35/box
5pcs/box

Suitable for 5 oz. to 7 oz. paper cups or plastic cups.



\$3.95 /bag

FREE SAMPLES!

Cotton Rolls - Non Sterile

Special Buy 4 @ \$3.55/bag
500pcs/bag

100% cotton, highly absorbent, contains no cellulose or rayon fibres. Keeps its shape.

Code	Colour
#992789	White



\$5.00 /bag



Code	Colour
#992796	Blue

Cotton Roll Holders

Special Buy 4 @ \$4.55/bag
100pcs/bag

Holds 2 cotton rolls.



\$8.20 /bag

FREE SAMPLES!



16mm - 20mm (Diameter)

Code	Colour
#992804	White

Cotton Balls - Non Sterile

Special Buy 4 @ \$7.45/bag
2000pcs/bag

100% cotton, non-sterile. Available in medium size (0.2g per ball) for a variety of uses. Available in non-acute only. Fluffy and super absorbent!

Super Absorbent!



\$4.40 /pack

FREE SAMPLES!

Cotton Sponges

Special Buy 4 @ \$4.00/pack
100pcs/pack

Made from 100% pure cotton with no added chemicals. Weight: 20g. Size: 60mm (L) x 50mm (W)

Code	Colour
#992826	White

Able to absorb 10 times their weight!



Sustainably Sourced!

\$2.90 /bag

FREE SAMPLES!

Virgin Paper Towels - C Fold

Special Buy 4 @ \$2.65/bag
200pcs/bag

Made from virgin paper, single-ply which comes from a sustainable and renewable forest source. Unfolded towel size: 220mm (L) x 230mm (W)

Code	Colour
#992731	White



\$2.30 /bag

FREE SAMPLES!

Recycled Paper Towels - C Fold

Special Buy 4 @ \$2.10/bag
200pcs/bag

Made from recycled paper, single-ply. Unfolded towel size: 220mm (L) x 230mm (W)

Code	Colour
#992737	White



Non-Woven Sponges

Made from 70% rayon and 30% polyester. 4-Ply, lint-free and highly absorbent!

FREE SAMPLES!

Size	Weight	Qty	Regular Price	Special Price	Code
50mm (L) x 50mm (W)	30gm	200pcs/pack	\$1.32/pack	Buy 4 @ \$1.20/pack	#992823
75mm (L) x 75mm (W)	30gm	200pcs/pack	\$2.65/pack	Buy 4 @ \$2.40/pack	#992824
100mm (L) x 100mm	30gm	200pcs/pack	\$4.75/pack	Buy 4 @ \$4.30/pack	#992825
50mm (L) x 50mm (W)	40gm	200pcs/pack	\$1.65/pack	Buy 4 @ \$1.50/pack	#992820
75mm (L) x 75mm (W)	40gm	200pcs/pack	\$3.30/pack	Buy 4 @ \$3.00/pack	#992821
100mm (L) x 100mm (W)	40gm	200pcs/pack	\$6.60/pack	Buy 4 @ \$6.00/pack	#992822



\$1.70 /pack

FREE SAMPLES!

MUST BUY!

Facial Tissue

Special Buy 4 @ \$1.55/pack
200pcs/pack

Soft and super absorbent 2-ply facial tissue with superior tensile strength. Does not rip easily even when wet, and no dust particles.

Code	Colour
#992708	White



Super Absorbent!

\$6.75 /bag

FREE SAMPLES!

Hand Towels

Special Buy 4 @ \$6.15/bag
200pcs/bag

3-Ply soft hand towel that is super absorbent! Size: 230mm (L) x 330mm (W)

Code	Colour
#992702	White



\$5.90 /bag

FREE SAMPLES!

Headrest Covers, 10" x 10"

Special Buy 4 @ \$5.35/bag
100pcs/bag

Made from tissue with poly-backing. The tissue layer provides a smooth and comfortable fit for your patients, while the poly-backing acts as a moisture barrier. Size 250mm (L) x 250mm (W)

Code	Colour
#992459	Blue
#992460	Green
#992461	Purple
#992462	Pink
#992463	White
#992464	Yellow



\$7.45 /bag

FREE SAMPLES!

Headrest Covers, 10" x 13"

Special Buy 4 @ \$6.75/bag
100pcs/bag

Made from tissue with poly-backing. The tissue layer provides a smooth and comfortable fit for your patients, while the poly-backing acts as a moisture barrier. Size 250mm (L) x 330mm (W)

Code	Colour
#992465	Blue
#992466	Green
#992467	Purple
#992468	Pink
#992469	White
#992470	Yellow



\$63.75 each

Tissue Box Holder (arm type)

Special Buy 4 @ \$57.95 each

This tissue box holder can be placed on the arm of any dental chair unit. Includes a hand mirror. Size: 245mm (L) x 138mm (W) x 60mm (H) *Cleaning instructions: Wipe with alcohol-based disinfectant solution.*

Code	Colour
#992700	Clear



\$63.75 each

Tissue Box Holder (pole type)

Special Buy 4 @ \$57.95 each

This tissue box holder can be mounted to a dental chairside pole. Includes a hand mirror. Suits all poles with 38mm - 52mm (Diameter). Size: 245mm (L) x 138mm (W) x 60mm (H) *Cleaning instructions: Wipe with alcohol-based disinfectant solution.*

Code	Colour
#992701	Clear



Headrest Covers - Clear Plastic

250pcs/box

Made from clear plastic. Provides durable protection against cross contamination.

Size options:
Medium: 240mm (L) x 280mm (W)
Large: 240mm (L) x 360mm (W)

FREE SAMPLES!

Size	Regular Price	Special Price	Code
Medium	\$11.80/box	Buy 4 @ \$10.70/box	#992446
Large	\$14.50/box	Buy 4 @ \$13.20/box	#992447

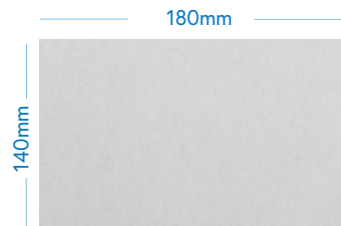

Mini Size

Disposable Tray Liners

Disposable tray liners made from standard paper stock prevent cross contamination and infection that could be caused by unclean trays. The mini size fits the Mini Aluminium Instrument Tray (#992543 series) and standard size fits the Standard Aluminium Instrument Tray (#992542 series).

Size options:
Mini: 140mm (L) x 180mm (W)
Standard: 180mm (L) x 280mm (W)

FREE SAMPLES!



Standard Size

Size	Qty	Reg Price	Special Price	Code
Mini (Paper + Poly)	100pcs/box	\$5.80/box	Buy 4 @ \$5.25/box	#992556
Mini (Paper)	250pcs/box	\$5.15/box	Buy 4 @ \$4.65/box	#992558
Standard (Paper + Poly)	100pcs/box	\$9.90/box	Buy 4 @ \$9.00/box	#992557
Standard (Paper)	250pcs/box	\$8.75/box	Buy 4 @ \$7.95/box	#992559



Cotton Tip Applicators

100pcs/bag

Non-sterile, made from all wood dowels with very tight 100% cotton bud to minimize linting. Non-shredding. Comes in a sealed autoclavable bag with indicator.

Size	Regular Price	Special Price	Code
80mm (L)	\$0.85/bag	Buy 4 @ \$0.75/bag	#993764
150mm (L)	\$1.05/bag	Buy 4 @ \$0.95/bag	#993765

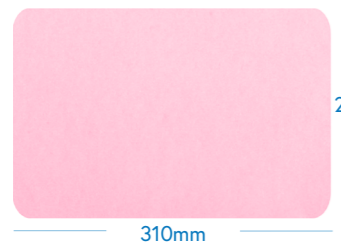

310mm

220mm

\$3.30 /bag

FREE SAMPLES!

Tray Liners - Ritter B

Special Buy 4 @ \$3.00/bag

100pcs/bag

Made from high-quality paper stock with improved moisture resistance to help prevent cross-contamination and unwanted water seepage. Fits Ritter B trays. Size: 310mm (L) x 220mm (W)

Code	Colour
#992563	White
#992564	Blue
#992565	Pink
#992566	Green
#992567	Purple
#992568	Yellow



430mm

280mm

\$7.95 /bag

FREE SAMPLES!

Tray Liners - Webber C

Special Buy 4 @ \$7.25/bag

100pcs/bag

Made from high-quality paper stock with improved moisture resistance to help prevent cross-contamination and unwanted water seepage. Fits Webber C trays. Size: 430mm (L) x 280mm (W)

Code	Colour
#992569	White

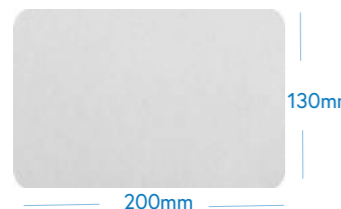

200mm

130mm

\$1.75 /bag

FREE SAMPLES!

Tray Liners - Mini F

Special Buy 4 @ \$1.60/bag

100pcs/bag

Made from high-quality paper stock with improved moisture resistance to help prevent cross-contamination and unwanted water seepage. Fits Mini F trays. Size: 200mm (L) x 130mm (W)

Code	Colour
#992572	White



310mm

220mm

\$4.00 /bag

FREE SAMPLES!

Liquid-Proof Tray Liners - Ritter B

Special Buy 4 @ \$3.65/bag

100pcs/bag

Polyethylene-backed paper prevents liquid seepage. Dual usage. Use poly side-down as a moisture barrier and poly side-up for quick mixing. Fits Ritter B trays. Size: 310mm (L) x 220mm (W)

Code	Colour
#992560	White
#992561	Blue



Paper Trays

50pcs/box

Disposable paper trays prevent cross contamination and infection that could be caused by unclean metal trays.

Size options:
Small: 200mm (L) x 100mm (W) x 15mm (H)
Medium: 220mm (L) x 130mm (W) x 15mm (H)
Large: 260mm (L) x 140mm (W) x 15mm (H)









Size	Regular Price	Special Price	Code
Small	\$4.75/box	Buy 2 @ \$4.30/box	#992528
Medium	\$6.25/box	Buy 2 @ \$5.70/box	#992529
Large	\$7.95/box	Buy 2 @ \$7.20/box	#992530

FREE SAMPLES!

U+ NiTi Files (Nickel Titanium)

Special Buy 4 @ \$39.95/pack
6pcs/pack

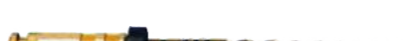
\$43.95 /pack

Size	LENGTH			Image
	19mm	21mm	25mm	
SX	#995560			
S1		#995473	#995481	
S2		#995474	#995482	
F1		#995475	#995483	
F2		#995476	#995484	
F3		#995477	#995485	
F4		#995479	#995487	
F5		#995480	#995488	
SX - F3		#995478	#995486	



NiTi H Files (Nickel Titanium)

Special Buy 4 @ \$6.95/pack
6pcs/pack

\$7.65 /pack

Length	SIZE							
	#8	#10	#15	#20	#25	#30	#35	#40
21mm	#993619	#993620	#993621	#993622	#993623	#993624	#993625	#993626
25mm	#993636	#993637	#993638	#993639	#993640	#993641	#993642	#993643

Length	SIZE							
	#45	#50	#55	#60	#70	#80	#15 - #40	#45 - #80
21mm	#993627	#993628	#993629	#993630	#993631	#993632	#993633	#993634
25mm	#993644	#993645	#993646	#993647	#993648	#993649	#993650	#993651



H Files (Stainless Steel)

Special Buy 4 @ \$5.35/pack
6pcs/pack

\$5.95 /pack

Length	SIZE								
	#6	#8	#10	#15	#20	#25	#30	#35	#40
21mm	#993550	#993551	#993552	#993553	#993554	#993555	#993556	#993557	#993558
25mm	#993567	#993568	#993569	#993570	#993571	#993572	#993573	#993574	#993575

Length	SIZE							
	#45	#50	#55	#60	#70	#80	#15 - #40	#45 - #80
21mm	#993559	#993560	#993561	#993562	#993563	#993564	#993565	#993566
25mm	#993576	#993577	#993578	#993579	#993580	#993581	#993582	#993583



NiTi K Files (Nickel Titanium)
Special Buy 4 @ \$6.95/pack
 6pcs/pack

\$7.65 /pack



NiTi Spreaders (Nickel Titanium)
Special Buy 4 @ \$6.95/pack
 6pcs/pack

\$7.65 /pack

SIZE								
Length	#8	#10	#15	#20	#25	#30	#35	#40

21mm	#993670	#993671	#993672	#993673	#993674	#993675	#993676	#993677
25mm	#993653	#993654	#993655	#993656	#993657	#993658	#993659	#993660

SIZE								
Length	#45	#50	#55	#60	#70	#80	#15 - #40	#45 - #80

21mm	#993678	#993679	#993680	#993681	#993682	#993683	#993684	#993685
25mm	#993661	#993662	#993663	#993664	#993665	#993666	#993667	#993668

SIZE							
Length	#15	#20	#25	#30	#35	#40	#15 - #40

21mm	#995428	#995429	#995430	#995431	#995432	#995433	#995434
25mm	#995435	#995436	#995437	#995438	#995439	#995440	#995441



K Files (Stainless Steel)
Special Buy 4 @ \$5.35/pack
 6pcs/pack

\$5.95 /pack



Spreaders (Stainless Steel)
Special Buy 4 @ \$5.35/pack
 6pcs/pack

\$5.95 /pack

SIZE									
Length	#6	#8	#10	#15	#20	#25	#30	#35	#40

21mm	#993601	#993602	#993603	#993604	#993605	#993606	#993607	#993608	#993609
25mm	#993584	#993585	#993586	#993587	#993588	#993589	#993590	#993591	#993592

SIZE									
Length	#45	#50	#55	#60	#70	#80	#15 - #40	#45 - #80	

21mm	#993610	#993611	#993612	#993613	#993614	#993615	#993616	#993617
25mm	#993593	#993594	#993595	#993596	#993597	#993598	#993599	#993600

SIZE							
Length	#15	#20	#25	#30	#35	#40	#15 - #40

21mm	#995442	#995443	#995444	#995445	#995446	#995447	#995448
25mm	#995449	#995450	#995451	#995452	#995453	#995454	#995455



NiTi Pluggers (Nickel Titanium)
Special Buy 4 @ \$6.95/pack
 6pcs/pack

\$7.65 /pack

Length	SIZE						
	#15	#20	#25	#30	#35	#40	#15 - #40
21mm	#995400	#995401	#995402	#995403	#995404	#995405	#995406
25mm	#995407	#995408	#995409	#995410	#995411	#995412	#995413



Engine H Files (Stainless Steel)
Special Buy 4 @ \$9.65/pack
 6pcs/pack

\$10.65 /pack

Length	SIZE						
	#15	#20	#25	#30	#35	#40	#15 - #40
21mm	#995496	#995497	#995498	#995499	#995500	#995501	#995502
25mm	#995503	#995504	#995505	#995506	#995507	#995508	#995509



Paste Carriers
Special Buy 4 @ \$10.35/pack
 4pcs/pack

\$11.40 /pack

Length	SIZE				
	#25	#30	#35	#40	#25 - #40
21mm	#995456	#995457	#995458	#995459	#995460
25mm	#995461	#995462	#995463	#995464	#995465



Pesso Reamers
Special Buy 4 @ \$12.65/pack
 6pcs/pack

\$13.95 /pack

Length	SIZE						
	#1	#2	#3	#4	#5	#6	#1 - #6
28mm	#993686	#993687	#993688	#993689	#993690	#993691	#993698
32mm	#993692	#993693	#993694	#993695	#993696	#993697	#993699



Pluggers (Stainless Steel)
Special Buy 4 @ \$5.35/pack
 6pcs/pack

5.95 /pack

Length	SIZE						
	#15	#20	#25	#30	#35	#40	#15 - #40
21mm	#995414	#995415	#995416	#995417	#995418	#995419	#995420
25mm	#995421	#995422	#995423	#995424	#995425	#995426	#995427



Gates Glidden Drills (Stainless Steel)

Special Buy 4 @ \$12.65/pack
6pcs/pack

\$13.95 /pack

	SIZE						
Length	#1/50	#2/70	#3/90	#4/110	#5/130	#6/150	#1 - #6
32mm	#995489	#995490	#995491	#995492	#995493	#995494	#995495

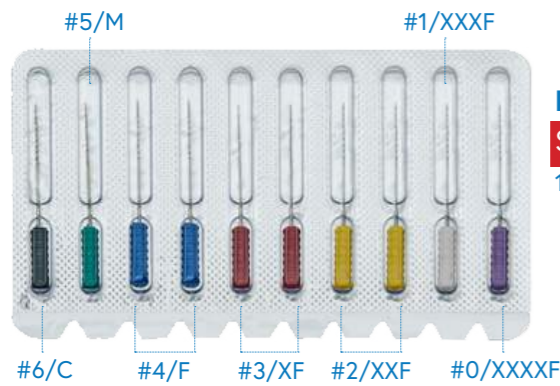

Barbed Broaches

Special Buy 4 @ \$5.15/pack
10pcs/pack

\$5.70 /pack

	SIZE							
Length	#0/XXXXF	#1/XXXF	#2/XXF	#3/XF	#4/F	#5/M	#6/C	All Sizes
21mm	#995466	#995467	#995468	#995469	#995470	#995471	#995472	#995553

Carbide Endo Burs, FG

Special Buy 4 @ \$11.35 each

\$12.50 each



Designed with long conical head, 7 helical cutting edges. Used for opening the pulp cavity to provide access to root orifices.

	SIZE		
	23mm	25mm	28mm
Endo Z	#995510	#995511	#995512

Gutta Percha Points

- Saves time with easy filling for faster and easier root canal obturation.
- Reaches the APX and completely seals the length of root canal.
- Length marking available for points of 18, 19, 20, 22 and 24mm.



Size	ISO		
	0.02	0.04	0.06
	Regular Price: \$9.85/pack	Regular Price: \$12.85/pack	Regular Price: \$12.85/pack
	Special Price: 4 @ \$8.95/pack	Special Price: 4 @ \$11.65/pack	Special Price: 4 @ \$11.65/pack
	120pcs/pack	60pcs/pack	60pcs/pack
#15	#995513	#995527	#995540
#20	#995514	#995528	#995541
#25	#995515	#995529	#995542
#30	#995516	#995530	#995543
#35	#995517	#995531	#995544
#40	#995518	#995532	#995545
#45	#995519	#995533	#995546
#50	#995520	#995534	#995547
#55	#995521	#995535	#995548
#60	#995522	#995536	#995549
#70	#995523	#995537	#995550
#80	#995524	#995538	#995551
#15 - #40	#995525	#995539	#995552
#45 - #80	#995526	-	-

AUXILIARY SIZE						
XF	FF	MF	F	FM	M	XF - M
Regular Price: \$9.85/pack						
Special Price: 4 @ \$8.95/pack						
100pcs/pack						
#995008	#995009	#995010	#995011	#995012	#995013	#995014

Paper Points

- Quick and easy depth measurements.
- Completely dries the full length of the root canal.
- Length marking available for points of 18, 19, 20, 22 and 24mm.



ISO		
0.02	0.04	0.06
Regular Price: \$8.45/pack	Regular Price: \$8.45/pack	Regular Price: \$8.45/pack
Special Price: 4 @ \$7.65/pack	Special Price: 4 @ \$7.65/pack	Special Price: 4 @ \$7.65/pack

Size	200pcs/pack	100pcs/pack	100pcs/pack
#15	#995561	#995575	#995588
#20	#995562	#995576	#995589
#25	#995563	#995577	#995590
#30	#995564	#995578	#995591
#35	#995565	#995579	#995592
#40	#995566	#995580	#995593
#45	#995567	#995581	#995594
#50	#995568	#995582	#995595
#55	#995569	#995583	#995596
#60	#995570	#995584	#995597
#70	#995571	#995585	#995598
#80	#995572	#995586	#995599
#15 - #40	#995573	#995587	#995000
#45 - #80	#995574	-	-

AUXILIARY SIZE						
XXF	XF	F	M	C	XC	XXF - XC
Regular Price: \$8.45/pack						
Special Price: 4 @ \$7.65/pack						
200pcs/pack						
#995001	#995002	#995003	#995004	#995005	#995006	#995007

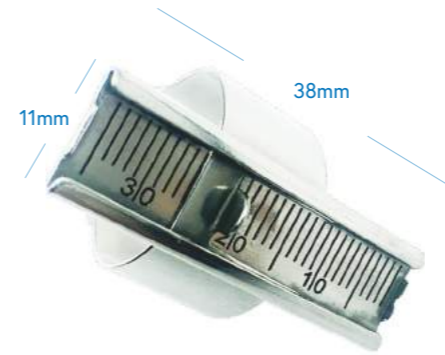

\$15.25 each

Endo Ruler - Stainless Steel
Special Buy 4 @ \$13.25 each

Ruler scale provides marking up to 35mm in 1mm increments. Ruler can be used by right and left-handed users. Autoclavable up to 135°C. Size: 38mm (L) x 11mm (W)

Code	Colour
#993068	White

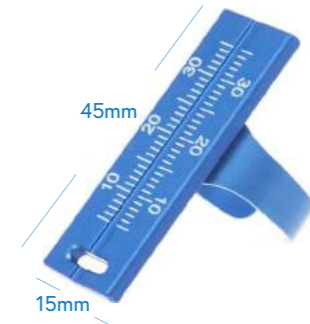

\$7.65 each

Endo Ruler
Special Buy 4 @ \$6.95 each

Ruler scale provides marking up to 35mm in 1mm increments. Ruler can be used by right and left-handed users. Autoclavable up to 135°C. Size: 45mm (L) x 15mm (W)

Code	Colour
#993009	Blue



\$8.99 /bag

Endo Stops
Special Buy 5 @ \$7.99/bag
100pcs/bag

These are easy-to-use silicone, round measuring stops that help establish the canal depth and measurement of each file during root canal therapies. Autoclavable up to 135°C.

Code	Colour
#993012	Red
#993013	White
#993014	Yellow
#993074	Dark Blue
#993075	Blue
#993076	Black
#993077	Purple
#993078	Green

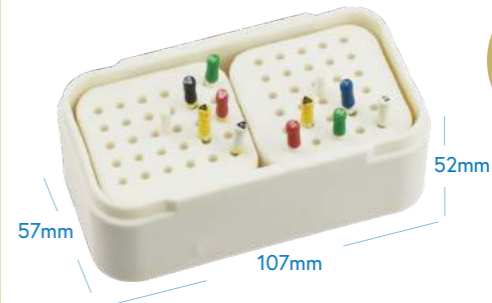

\$9.85 each

Endodontic Case - Large A
Special Buy 4 @ \$8.95 each

Ideal for holding H Files and reamers with a total of 60 holes. Autoclavable up to 135°. Size: 107mm (L) x 57mm (W) x 52mm (H)

Code	Colour
#993046	Ivory



\$9.85 each

Endodontic Case - Large B
Special Buy 4 @ \$8.95 each

Ideal for keeping colour-coded gutta percha points and paper points. Autoclavable up to 135°. Size: 107mm (L) x 57mm (W) x 52mm (H)

Code	Colour
#993045	Ivory



\$9.85 each

Endodontic Case - Large C
Special Buy 4 @ \$8.95 each

Ideal for keeping H Files, reamers, gutta percha and paper points. Can be sterilised at the same time. Autoclavable up to 135°. Size: 107mm (L) x 57mm (W) x 52mm (H)

Code	Colour
#993044	Ivory

ENDODONTICS

ENDODONTICS

NuMedical

NuMedical

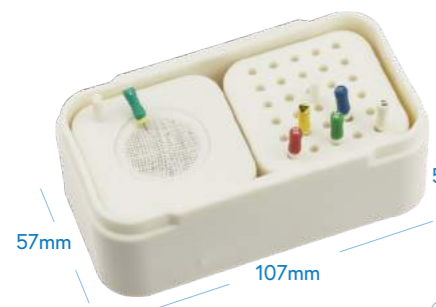

\$9.85 each

52mm Instruments not included.

Endodontic Case - Large D
Special Buy 4 @ \$8.95 each

Ideal for keeping up to 30 H Files and reamers. Sludge on files can be easily removed by the file cleaner. The gauze can be replaced. Autoclavable up to 135°. Size: 107mm (L) x 57mm (W) x 52mm (H)



Code	Colour
#993043	Ivory



\$9.85 each

52mm Instruments not included.

Endodontic Case - Large E
Special Buy 4 @ \$8.95 each

Ideal for autoclave sterilisation. Suitable for FG, RA and HP bur. Autoclavable up to 135°. Size: 107mm (L) x 57mm (W) x 52mm (H)



Code	Colour
#993042	Ivory



\$10.30 each

Instruments not included.

Triangular Endo Ring
Special Buy 4 @ \$9.35 each

Made from high-heat resistant plastic. Used to clean, sterilise and stage instruments. Autoclavable up to 135°C. *Cushion included.

Code	Colour
#993002	Blue



\$10.30 each

35mm

Endo Stand
Special Buy 4 @ \$9.35 each

Made from high-heat resistant plastic. Used to clean, sterilise and stage instruments. Autoclavable up to 135°C. Size: 35mm (H) x 55mm (Diameter) *Cushion included.

Code	Colour
#993003	Blue



\$5.90 each

57mm

Endodontic Case - Small
Special Buy 4 @ \$5.35 each

Ideal for storing cotton rolls, cotton balls or small instruments. Can be sterilised. Autoclavable up to 135°. Size: 57mm (L) x 57mm (W) x 57mm (H)



Code	Colour
#993040	Ivory



\$5.90 each

Instruments not included.

Endodontic Case - Small F
Special Buy 4 @ \$5.35 each

Ideal for keeping H-Files and reamers. Autoclavable up to 135°. Size: 57mm (L) x 57mm (W) x 57mm (H)



Code	Colour
#993065	Ivory



\$12.25 /box

Endo Cushions - Triangle
Special Buy 4 @ \$11.15/box
50pcs/box

Disposable endo cushions. Compatible with Triangular Endo Ring (#993002).

Code	Colour
#993005	Blue



\$12.25 /box

Endo Cushions - Round
Special Buy 4 @ \$11.15/box
50pcs/box

Disposable endo cushions. Compatible with Endo Stand (#993003). Size: 65mm (Diameter)

Code	Colour
#993006	Blue

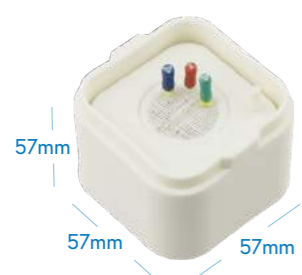

\$5.90 each

Instruments not included.

Endodontic Case - Small G
Special Buy 4 @ \$5.35 each

Sludge on files can be easily removed by the file cleaner. The gauze can be replaced. Autoclavable up to 135°. Size: 57mm (L) x 57mm (W) x 57mm (H)



Code	Colour
#993066	Ivory

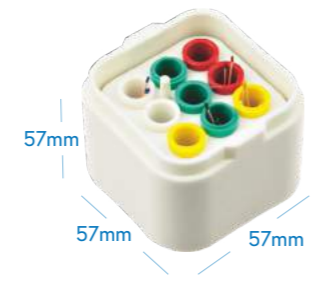

\$5.90 each

Instruments not included.

Endodontic Case - Small H
Special Buy 4 @ \$5.35 each

Ideal for keeping gutta-percha and paper points classified by colour. Autoclavable up to 135°. Size: 57mm (L) x 57mm (W) x 57mm (H)



Code	Colour
#993067	Ivory

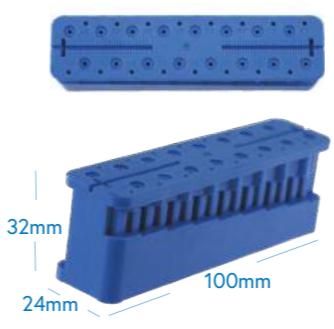

\$17.80 each

Endo Measuring Block - Plastic
Special Buy 4 @ \$16.20 each

Made from high-heat resistant plastic. Easy-to-use and accurate. Autoclavable up to 135°. Size: 100mm (L) x 24mm (W) x 32mm (H)

Code	Colour
#993008	Blue

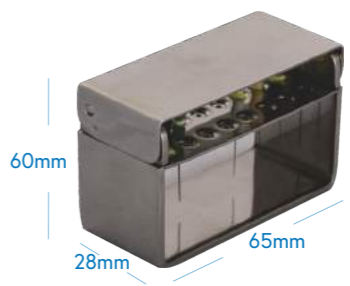

\$97.60 each

Instruments not included.

Endo Multi Holder
Special Buy 4 @ \$88.70 each

Ideal for cleaning and autoclaving endo instruments. Holds 16 files (all lengths). Autoclavable up to 135°. Size: 65mm (L) x 28mm (W) x 60mm (H)

Code	Colour
#993001	Stainless Steel



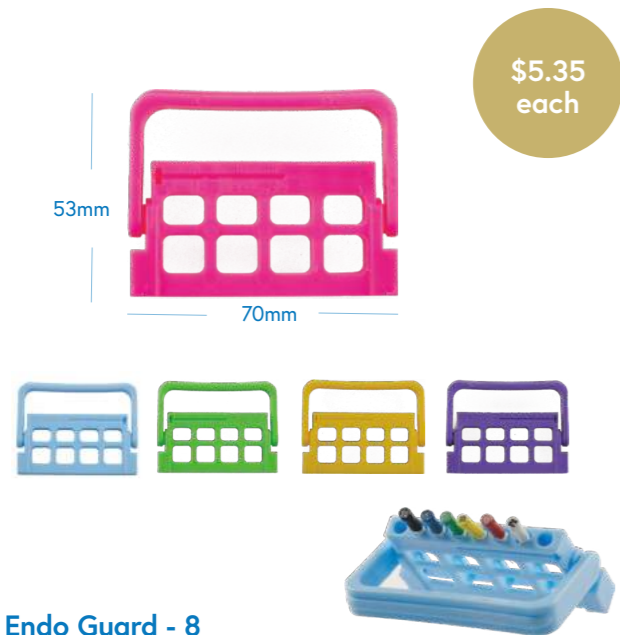

\$5.35 each

Endo Guard - 8

Special Buy 4 @ \$4.90 each

Ideal for cleaning and autoclaving endo instruments with integrated endo ruler. Holds 8 engine or hand files (all lengths). Can be rotated to become a stand. Autoclavable up to 135°. Size: 70mm (L) x 53mm (W)

Code	Colour
#993069	Blue
#993070	Pink
#993071	Green
#993072	Yellow
#993073	Purple



\$8.05 each

Endo Guard - 16

Special Buy 4 @ \$7.35 each

Ideal for cleaning and autoclaving endo instruments with integrated endo ruler. Holds 16 engine or hand files (all lengths). Can be rotated to become a stand. Autoclavable up to 135°. Guards can be joined together. Size: 75mm (L) x 52mm (W)

Code	Colour
#994049	Blue
#994050	Red
#994051	Green
#994052	Yellow
#994053	Purple



\$9.50 /box

Luer-Lock Syringe, 3cc

Special Buy 4 @ \$8.55/box
100pcs/box

For surgical site irrigation. Single-use. *1cc = 1ml

Code
#993056



\$9.50 /box

Luer-Lock Syringe, 6cc

Special Buy 4 @ \$8.55/box
100pcs/box

For surgical site irrigation. Single-use. *1cc = 1ml

Code
#993057



\$14.70 /bag

Endo Mixing Tips

Special Buy 4 @ \$13.35/bag
50pcs/bag

Disposable mixing tips ideal for mixing dental cold-whitening cements, resins, curing cements, self-curing adhesive materials, crown and bridge materials, composite inlays, etc.

Code	Colour
#991087	Brown



\$14.70 /bag

Endo Mixing Tips

Special Buy 4 @ \$13.35/bag
50pcs/bag

Disposable mixing tips ideal for mixing dental cold-whitening cements, resins, curing cements, self-curing adhesive materials, crown and bridge materials, composite inlays, etc.

Code	Colour
#991091	Brown



\$14.20 /box

Luer-Lock Syringe, 12cc

Special Buy 4 @ \$12.90/box
100pcs/box

For surgical site irrigation. Single-use. *1cc = 1ml

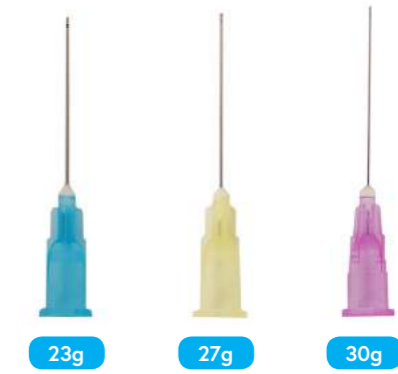

\$23.40 /box

Irrigating Needle Tips - Closed End

Special Buy 4 @ \$21.25/box
100pcs/box

Bendable needle tip at 1°. Used to irrigate subgingival surgical sites and the sulcus. Closed-end with side vent for use in apical proximity. Universal luer-style design. Single-use.

Size	Code	Colour
23g	#993052	Blue
27g	#993053	Yellow
30g	#993054	Purple

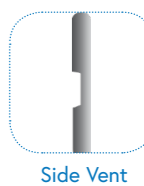

EVACUATION

EVACUATION



\$21.95 /bag

Adult 24mm
Adult 20mm
Pedo 16mm

Aspirator Tips - Angled 16mm

Special Buy 4 @ \$19.95/bag

10pcs/bag

Made from high quality plastic, suitable for cheek retraction. Autoclavable up to 135°. Assorted colours of blue, green, yellow, purple and lime.

Size	Code	Colour
Adult 24mm	#991281	Assorted
Adult 20mm	#991282	Assorted
Pedo 16mm	#991283	Assorted



\$21.95 /bag

Adult 22mm
Adult 20mm
Pedo 16mm

Aspirator Tips - Curved 16mm

Special Buy 4 @ \$19.95/bag

10pcs/bag

Made from high quality plastic, suitable for cheek retraction. Autoclavable up to 135°. Assorted colours of blue, green, yellow, purple and lime.

Size	Code	Colour
Adult 22mm	#991284	Assorted
Adult 20mm	#991285	Assorted
Pedo 16mm	#991286	Assorted



\$21.95 /bag

Adult 20mm
Pedo 16mm

Aspirator Tips - Curved 11mm

Special Buy 4 @ \$19.95/bag

10pcs/bag

Made from high quality plastic, suitable for cheek retraction. Autoclavable up to 135°. Assorted colours of blue, green, yellow, purple and lime.

Size	Code	Colour
Adult 20mm	#991287	Assorted
Pedo 16mm	#991288	Assorted



\$6.55 /bag

3.6mm
6.2mm
2.1mm
1/8"
1/4"
1/16"

Surgical Aspirator Tips, angled 30°

Special Buy 4 @ \$5.95/bag

25pcs/bag

Made from 100% durable polyurethane, latex-free. Fits 11mm suction holders. Autoclavable up to 135°C. Single-use.

Size	Code	Colour
1/8" tip	#991248	White
1/4" tip	#991249	Green
1/16" tip	#991250	Blue



\$4.95 /bag

FREE SAMPLES!

Available in HOT & NEW Promo! (PG 4)

Disposable HVE Aspirator Tips, Assorted

Special Buy 4 @ \$4.50/bag

100pcs/bag

Vented HVE tips designed with unique 'S' tip and non-sharp edges for superior comfort. Assorted colours of purple, yellow, lime, blue and pink. Autoclavable up to 135°C. Single-use. Size: 145mm (L) x 11mm (Diameter)

Code	Colour
#991233	Assorted



\$3.65 /bag

FREE SAMPLES!

Disposable HVE Aspirator Tips, White

Special Buy 4 @ \$3.25/bag

100pcs/bag

Vented HVE tips designed with unique 'S' tip and non-sharp edges for superior comfort. Autoclavable up to 135°C. Single-use. Size: 145mm (L) x 11mm (Diameter)

Code	Colour
#991232	White



\$4.95 /bag

FREE SAMPLES!

Available in HOT & NEW Promo! (PG 4)

Saliva Ejectors, Assorted

Special Buy 4 @ \$4.50/bag

100pcs/bag

Disposable saliva ejectors for high volume evacuation of saliva and water from the oral cavity. Bendable with non-removable tip. Clear tips with assorted colour tubes of blue, green, yellow and purple. Size: 150mm (L) x 6.5mm (Diameter)

Code
#991240



\$3.85 /bag

FREE SAMPLES!

Available in HOT & NEW Promo! (PG 4)

Saliva Ejectors

Special Buy 4 @ \$3.50/bag

100pcs/bag

Disposable saliva ejectors for high volume evacuation of saliva and water from the oral cavity. Bendable with non-removable tip. Size: 142mm (L) x 6.5mm (Diameter)

Code	Colour
#991241	Blue Tip/Clear
#991242	White Tip/Clear
#991243	White Tip/White



\$9.55 /bag

Saliva Ejector Traps

Special Buy 4 @ \$8.65/bag

72pcs/bag

Standard No: 5508. Disposable.

Code	Colour
#991265	White



Fits HVE Tips

\$27.45 each

Saliva ejectors and HVE tips not included.

Saliva Ejector Dispenser

Special Buy 4 @ \$24.95 each

Ideal for storing saliva ejectors or HVE tips. Size: 170mm (H)

Cleaning instructions: Use only soap and water on acrylic surface. Alcohol or ammonia-based disinfectants may cause cracks to appear.

Code	Colour
#991244	Clear



\$9.75 /bag

Saliva Ejector Cushions

Special Buy 4 @ \$8.85/bag

50pcs/bag

These cushions are used together with saliva ejectors. The cushion fits and slides easily over the saliva ejector to help prevent tissue grabbing or irritation, lowers suction noise and provides efficient suction and evacuation with maximum patient comfort. Made from non-latex open cell foam. Size: 25mm (L) x 15.8mm (W)



Code	Colour
#990905	Blue



\$2.85 each

Snap-On Saliva Ejector Tips

Special Buy 4 @ \$2.50 each

Made from high quality silicone. Autoclavable up to 135°C.

Code	Colour
#991276	Grey

EVACUATION



\$21.95 each

Metal Suction Tube

Special Buy 4 @ \$19.95 each

Ideal for hi-volume evacuation of saliva and water from the oral cavity. Fits 11mm suction holders. Autoclavable up to 135°. Size: 130mm (L) x 11mm (Diameter)

Code Colour
#991235 Chrome



\$6.59 /bag

Suction Tip Sleeves

Special Buy 4 @ \$5.99/bag
10pcs/bag

Made from soft silicone material Compatible with Metal Suction Tube (#991235). Autoclavable up to 135°. Size: 40mm (Diameter)



Code Colour
#991236 Blue



\$81.90 /box

Disposable Canisters A

Special Buy 4 @ \$74.45/box
12pcs/box

Filters for central vacuum pumps, threads-internal. Fits: Air Technigues-Vacstar Models, Apollo 1 hp, 1.5 Single: Tandem Models, 1, 2hp Den-Tal-EZ Single Models, Ohmeda-Matrix most models, Turbine Industries, Techwest-Whirl Vac Models, Vacudent-Workhorse Single and other units.

Code Colour
#991266 Clear



\$81.90 /box

Disposable Canisters B

Special Buy 4 @ \$74.45/box
8pcs/box

Filters for central vacuum pumps, threads-Internal, Fits: Den-Tal-Ez dual models made after 1978, Dentsply made after 1991, Matrix 1000, 2000 and Drymax, Vortex Vacuum Pump (JDS).

Code Colour
#991267 Clear



\$1.95 each

Aspirator Brushes, X-Fine

Special Buy 4 @ \$1.65 each

Stainless steel aspirator brushes with rigid bristles for effective cleaning of evacuation tubes. Autoclavable up to 135°. Size: 165mm (L) x 5mm (W)

Code
#991256



\$1.95 each

Aspirator Brushes, Fine

Special Buy 4 @ \$1.65 each

Stainless steel aspirator brushes with rigid bristles for effective cleaning of evacuation tubes. Autoclavable up to 135°. Size: 170mm (L) x 8mm (W)

Code
#991257



\$2.15 each

Aspirator Brushes, Medium

Special Buy 4 @ \$1.95 each

Stainless steel aspirator brushes with rigid bristles for effective cleaning of evacuation tubes. Autoclavable up to 135°. Size: 225mm (L) x 14mm (W)

Code
#991258



\$2.15 each

Aspirator Brushes, Large

Special Buy 4 @ \$1.95 each

Stainless steel aspirator brushes with rigid bristles for effective cleaning of evacuation tubes. Autoclavable up to 135°. Size: 225mm (L) x 20mm (W)

Code
#991259



\$5.30 /bag

Disposable Traps A

Special Buy 4 @ \$4.80/bag
12pcs/bag

Standard No: 5501. Used to replace the existing trap in your evacuation unit or cuspidor to reduce the risks of infection and cross-contamination, while improving the performance of your evacuation system. Fits: Belmont, Biotec, Chayes, DentalEZ, Dentsply, Pelton & Crane, Prisma and others. Size: 54mm (Diameter)

Code Colour
#991263 White



\$5.30 /bag

Disposable Traps B

Special Buy 4 @ \$4.80/bag
12pcs/bag

Standard No: 5503. Used to replace the existing trap in your evacuation unit or cuspidor to reduce the risks of infection and cross-contamination, while improving the performance of your evacuation system. Fits: A-Dec models with plastic canisters. Size: 48mm (Diameter)

Code Colour
#991264 White



\$5.30 /bag

Disposable Traps C

Special Buy 4 @ \$4.80/bag
12pcs/bag

Standard No: 5505. These disposable traps are designed to replace the existing trap in your evacuation unit or cuspidor to reduce the risks of infection and cross-contamination, while improving the performance of your evacuation system. Fits: Pelton & Crane with white plastic canisters. Size: 69mm (L)

Code Colour
#991275 White



\$5.30 /bag

Disposable Traps D

Special Buy 4 @ \$4.80/bag
12pcs/bag

Standard No: 5500. Fits: A-Dec, Cascade, Performer. Size: 31mm (Diameter)

Code Colour
#991279 White

EVACUATION

EVACUATION

NuMedical

NuMedical

EVACUATION

EVACUATION

EVACUATION

EVACUATION

NuMedical

NuMedical



\$5.30 /bag

Disposable Traps E
Special Buy 4 @ \$4.80/bag
 12pcs/bag

Standard No: 5509. Fits: DCI/Belmont Reality models, System 6000 models. Size: 38mm (Diameter)

Code	Colour
#991280	White



\$3.90 /bag

Cuspidor Strainers A
Special Buy 4 @ \$3.55/bag
 12pcs/bag

Standard No: 6100. Fits most cuspidor bowls such as A-Dec, Ampco, Belmont, Dabi, Atlante, Dansereau, DCI, Den-Tal-Ez, Forest, Knight, Marus, MDT, Proma, Ritter, Schein. Disposable.



Code	Colour
#991268	White



\$19.00 each

Rotary Saliva Ejector Valve
Special Buy 4 @ \$17.35 each

Autoclavable up to 135°.

Code	Colour
#991272	Grey



\$19.00 each

Rotary HVE Lever
Special Buy 4 @ \$17.35 each

Autoclavable up to 135°.

Code	Colour
#991270	Grey



\$3.90 /bag

Cuspidor Strainers B
Special Buy 4 @ \$3.55/bag
 12pcs/bag

Standard No: 6200. Fits Siemens, Planmeca and many cuspidor with small openings. Disposable.



Code	Colour
#991277	White



\$3.90 /bag

Cuspidor Strainers C
Special Buy 4 @ \$3.55/bag
 12pcs/bag

Standard No: 6400. Fits: A-Dec, Cascade and Performer cuspidor bowls. Disposable.



Code	Colour
#991278	White



\$5.00 each

Suction Tube Adaptors A
Special Buy 4 @ \$4.55 each

Designed to connect onto a 16mm terminal to reduce to 11mm. Autoclavable up to 135°C.

Code	Colour
#991260	White



\$5.00 each

Suction Tube Adaptors B
Special Buy 4 @ \$4.55 each

Designed to connect onto a 11mm terminal to reduce to 6.5mm. Autoclavable up to 135°C.

Code	Colour
#991261	White



\$19.00 each

HVE Valve Lever
Special Buy 4 @ \$17.35 each

Autoclavable up to 135°.

Code	Colour
#991269	Grey



\$19.00 each

Saliva Ejector Valve Lever
Special Buy 4 @ \$17.35 each

Autoclavable up to 135°.

Code	Colour
#991271	Grey



\$2.25 each

HVE Lever
Special Buy 4 @ \$2.05 each

Autoclavable up to 135°.

Code	Colour
#991273	Grey



\$2.35 each

Saliva Ejector Lever
Special Buy 4 @ \$2.05 each

Autoclavable up to 135°.

Code	Colour
#991274	Grey

DTE[®]



LED CURING LIGHTS

EXCLUSIVELY DISTRIBUTED BY



1 SECOND
CURING TIME (2mm RESINS)
HIGH LIGHT INTENSITY



EXPERT IN LED CURING LIGHTS!

With 14 years of technological experience including 41 patents and 8 invention patents!
Over 600,000 units sold worldwide!

NuMedical is proud to partner with Woodpecker to bring DTE[®] LED curing lights to dental professionals in Australia.

Page 72 - 73



\$209.95 each

ONE YEAR WARRANTY

DTE iLED Curing Light

Special Buy 4 @ \$189.65 each

- Features:**
- 360° rotatable head
 - Constant light output
 - Ergonomic design
 - Fast curing time (only 1 second)

- Specifications:**
- Light intensity: 1000 - 2500mW/cm²
- Size: 25mm x 25mm x 240m

Code	Colour
#992846	White
#992913	Purple

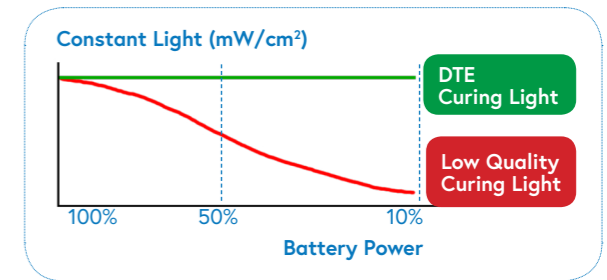

\$55.95 each

DTE iLED Light Guide

Special Buy 4 @ \$50.85 each

Compatible with DTE iLED Curing Light.
Light intensity: 1000 - 2500mW/cm²

Code	Colour
#992917	White
#992918	Purple



\$15.05 each

DTE Protective Light Shield, Type 4

Special Buy 4 @ \$13.65 each

Filters out blue light. Compatible with DTE iLED Curing Light.

Code	Colour
#992919	Orange



DTE LUX E PLUS LED Curing Light
Special Buy 4 @ \$145.35 each

Features:

- Constant light output
- Working modes: Full, Ramping, Pulse
- Time setting: 5s, 10s, 15s, 20s
- Ergonomic design
- Fast curing time (only 3 seconds)

Specifications:

- Light intensity: 800 - 1600mW/cm²
- Optical fiber autoclavable up to 135°C and up to high pressure of 0.22mPa

Size: Tip 40mm x 50mm x 260mm

Code	Colour
#992845	White

ONE YEAR WARRANTY

\$159.90 each

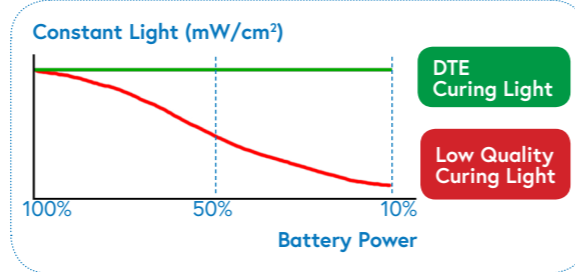

\$8.10 each

Light Protective Hand Shield
Special Buy 4 @ \$7.35 each

Hand-held protective shield.
 Size: 260mm (L) x 125mm (W)

Code	Colour
#992958	Orange



\$6.55 each

DTE Curing Light Depth Gauge
Special Buy 4 @ \$5.95 each

Designed to test the effectiveness of curing light on filling materials. Simply fill one of the holes with the filling material to the desired depth, and cure it with your curing light to ensure successful curing on the actual tooth.

Code	Colour
#992843	Blue



\$49.65 each

DTE LUX E PLUS LED Light Guide, 8mm
Special Buy 4 @ \$45.15 each

Designed with beveled optical fiber for better access to teeth in the posterior section of the mouth. Light intensity: 800 - 1600mW/cm²

Code
#992911



\$39.95 each

DTE LUX E PLUS Replacement Battery

Reliable lithium battery with CE certification.

Code
#992842



\$24.75 each

NuMedical Light Guide, 12mm
Special Buy 4 @ \$22.55 each

Compatible with most curing lights. Curing depth more than 3mm. Size: 12mm (Diameter) x 15mm (H)

Code
#992951



\$24.75 each

NuMedical Light Guide, 10mm
Special Buy 4 @ \$22.55 each

Compatible with most curing lights. Curing depth more than 3mm. Size: 10mm (Diameter) x 15mm (H)

Code
#992952



\$15.05 each

DTE Protective Light Shield, Type 2
Special Buy 4 @ \$13.65 each

Filters out blue light. Compatible with DTE LUX E PLUS Curing Light.

Code	Colour
#992844	Orange



\$15.05 each

DTE Protective Light Shield, Type 3
Special Buy 4 @ \$13.65 each

Filters out blue light. Compatible with DTE LUX E PLUS Curing Light.

Code	Colour
#992914	Orange



\$24.75 each

NuMedical Light Guide, 10mm
Special Buy 4 @ \$22.55 each

Compatible with most curing lights. Curing depth more than 3mm. Size: 12mm (Diameter) x 22mm (H)

Code
#992953



\$96.65 each

NuMedical Handpiece, Non-LED

Special Buy 4 @ \$87.55 each

Compatible with EMS type scaler. Autoclavable up to 135°C.

Code #992965



\$96.65 each

NuMedical Handpiece, Non-LED

Special Buy 4 @ \$87.55 each

Compatible with SATELEC type scaler. Autoclavable up to 135°C.

Code #992966



\$180.35 each

EASYINSMILE LED Handpiece

Special Buy 4 @ \$163.95 each

Full metal LED handpiece. Compatible with Woodpecker and EMS type scaler. Autoclavable up to 135°C.

Code #992949



\$499.00 each

Woodpecker YZ-1L LED Handpiece

Special Buy 4 @ \$455.00 each

Full metal LED handpiece. Autoclavable up to 135°C.

Code #992855



\$129.00 each

Woodpecker HW-3H Handpiece, Non-LED

Special Buy 4 @ \$119.00 each

Compatible with Woodpecker and EMS type scaler. Autoclavable up to 135°C.

Code #992856



\$169.00 each



Woodpecker HW-5L LED Handpiece

Special Buy 4 @ \$155.00 each

Compatible with Woodpecker and EMS type scaler. Autoclavable up to 135°C. Option of metal head or plastic head.

Head	Code
Metal	#992857
Plastic	#992915



\$39.55 each

Scaler Handpiece Cables, Non-LED

Special Buy 4 @ \$35.95 each

Type	Code
EMS, Woodpecker	#992963
SATELEC	#992964



\$50.55 each

Scaler Handpiece Cables, LED

Special Buy 4 @ \$45.95 each

Type	Code
EMS, Woodpecker	#992945
SATELEC	#992946



\$129.00 each

DTE HD-7H Handpiece, Non-LED

Special Buy 4 @ \$119.00 each

Compatible with Woodpecker, DTE and SATELEC type scaler. Autoclavable up to 135°C.

Code #992858



\$169.00 each



DTE HD-7L LED Handpiece

Special Buy 4 @ \$155.00 each

Compatible with Woodpecker, DTE and SATELEC type scaler. Autoclavable up to 135°C. Option of metal head or plastic head.

Head	Code
Metal	#992859
Plastic	#992916



\$9.85 each

Torque Wrench

Special Buy 4 @ \$8.95 each

Type	Code
EMS, Woodpecker	#992941
Woodpecker DTE, SATELEC, NSK	#992942
SIRONA	#992943



\$14.70 /bottle

Woodpecker Scaler U-Files

Special Buy 4 @ \$13.35/bottle

Each bottle comes with 6 pieces of U-Files. Option of 6 file sizes.

Size	Code
#15	#994064
#20	#994065
#25	#994066
#30	#994067
#35	#994068
#40	#994069



\$13.70 each

Endo Wrench

Special Buy 4 @ \$12.45 each

A double-ended endo wrench with a different-sized opening at each end. The end with a narrow opening is used for screwing/unscrewing scaler tips of Kavo or Sirona type scaler handpiece. The end with a wider opening is used for changing the ultrasonic U-file and screwing/unscrewing the endo chuck.

Code
#992961



Woodpecker Autoclavable Tip Holder

Holds up to 6 tips. Autoclavable up to 135°C.

Type	Regular Price	Special Price	Code
1	\$12.70 each	Buy 4 @ \$11.55 each	#992959
2	\$14.70 each	Buy 4 @ \$13.35 each	#992960

Woodpecker Woodpex III Apex Locator

Special Buy 4 @ \$369.00/set

\$406.00 /set

ONE YEAR WARRANTY



LCD Display

Adjustable Viewing Angle

Features:

- LCD display
- The trajectory of the file can be clearly shown with different colours
- Advanced multiple frequency technology
- Automatic calibration ensures accurate measurements
- Autoclavable file clip, file hook and file probe
- Different beep sounds to indicate position of file in the root canal
- Rechargeable lithium battery
- Adjustable viewing angle

Specifications:

- Battery: 3.7V/750mAh
- Power consumption: ≤0.5W
- Screen: 4.5" LCD
- Main unit weight: 350g
- Dimensions: 84mm x 88mm x 112mm

Each set comes with 1x Woodpex III Apex Locator system, 1x file clip, 1x file hook and 1x file probe.

Code Colour
#992905 Gold

Woodpecker Woodpex III Apex Locator Accessories



Type	Regular Price	Special Price	Code
File Clip	\$28.55 each	Buy 4 @ \$25.95 each	#992909
File Hook	\$28.55 each	Buy 4 @ \$25.95 each	#992907
File Probe	\$28.55 each	Buy 4 @ \$25.95 each	#992906
Cord	\$28.55 each	Buy 4 @ \$25.95 each	#992908



SCALER TIPS



MORE POWERFUL THAN YOU CAN IMAGINE

Over 200 different types of scaler tips for scaling, periodontal surgeries, crown & bridges, endodontics, orthodontics, bone surgeries, implants, sinus lift surgeries, exelcymosis and more.

We have them all!

DISTRIBUTED BY



Check scaler tip compatibility with Woodpecker, DTE, EMS, SATELEC, NSK, SIRONA, Amdent, KaVo and Mectron ultrasonic scalers.

















NuMedical is proud to partner with Woodpecker to bring scaler tips of the highest quality to dental professionals in Australia.

Page 79 - 92

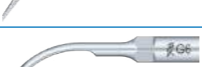
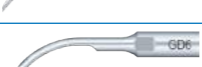

Scaler Tips, Stainless Steel

Note:
 EMS is a registered trademark of Electro Medical System S.A. Switzerland.
 SATELEC is a registered trademark of Satelec/Acteon Group France.
 NSK is a registered trademark of Nakanishi Inc. Japan.
 SIRONA is a registered trademark of Sirona Dental System.
 Woodpecker and DTE are registered trademarks of Guilin Woodpecker Medical Instrument China.
 Amdent is a registered trademark of Amdent Sweden.

SCALING				
	Regular Price per pc	Special Price per pc	Code	Purpose
G1 (Woodpecker, EMS type)	\$9.95	Buy 4 @ \$8.95	#995600	Supragingival Scaling 
GD1 (DTE,SATELEC,NSK type)	\$9.95	Buy 4 @ \$8.95	#995601	Supragingival Scaling 
GS1 (SIRONA type)	\$9.95	Buy 4 @ \$8.95	#995602	Supragingival Scaling 
G2 (Woodpecker, EMS type)	\$9.95	Buy 4 @ \$8.95	#995603	Supragingival Scaling 
GD2 (DTE,SATELEC,NSK type)	\$9.95	Buy 4 @ \$8.95	#995604	Supragingival Scaling 
GS2 (SIRONA type)	\$9.95	Buy 4 @ \$8.95	#995605	Supragingival Scaling 
G3 (Woodpecker, EMS type)	\$10.85	Buy 4 @ \$9.65	#995606	Supragingival Scaling 
GD3 (DTE,SATELEC,NSK type)	\$10.85	Buy 4 @ \$9.65	#995607	Supragingival Scaling 
GS3 (SIRONA type)	\$10.85	Buy 4 @ \$9.65	#995608	Supragingival Scaling 
G4 (Woodpecker, EMS type)	\$10.85	Buy 4 @ \$9.65	#995609	Supragingival Scaling 
GD4 (DTE,SATELEC,NSK type)	\$10.85	Buy 4 @ \$9.65	#995610	Supragingival Scaling 
GS4 (SIRONA type)	\$10.85	Buy 4 @ \$9.65	#995611	Supragingival Scaling 
G5 (Woodpecker, EMS type)	\$10.85	Buy 4 @ \$9.65	#995612	Supragingival Scaling 
GD5 (DTE,SATELEC,NSK type)	\$10.85	Buy 4 @ \$9.65	#995613	Supragingival Scaling 
GS5 (SIRONA type)	\$10.85	Buy 4 @ \$9.65	#995614	Supragingival Scaling 
G6 (Woodpecker, EMS type)	\$10.85	Buy 4 @ \$9.65	#995615	Supragingival Scaling 
GD6 (DTE,SATELEC,NSK type)	\$10.85	Buy 4 @ \$9.65	#995616	Supragingival Scaling 
GS6 (SIRONA type)	\$10.85	Buy 4 @ \$9.65	#995617	Supragingival Scaling 
A1 (Amdent type)	\$22.15	Buy 4 @ \$19.95	#995708	Supragingival Scaling 
A2 (Amdent type)	\$22.15	Buy 4 @ \$19.95	#995709	Supragingival Scaling 



Scaler Tips, Stainless Steel

Note:
 KaVo is a registered trademark of KaVo Dental GmbH Germany.

SCALING				
	Regular Price per pc	Special Price per pc	Code	Purpose
GK1 (KaVo type)	\$29.85	Buy 4 @ \$27.15	#995756	Supragingival and subgingival scaling 
GK2 (KaVo type)	\$29.85	Buy 4 @ \$27.15	#995757	Supragingival and subgingival scaling 
GK3 (KaVo type)	\$29.85	Buy 4 @ \$27.15	#995758	Supragingival and subgingival scaling 
GK4 (KaVo type)	\$29.85	Buy 4 @ \$27.15	#995759	Supragingival and subgingival scaling 
GK5 (KaVo type)	\$29.85	Buy 4 @ \$27.15	#995760	Supragingival and subgingival scaling 
GK6 (KaVo type)	\$29.85	Buy 4 @ \$27.15	#995761	Supragingival and subgingival scaling 
GK7 (KaVo type)	\$29.85	Buy 4 @ \$27.15	#995762	Supragingival and subgingival scaling 
GK11 (KaVo type)	\$29.85	Buy 4 @ \$27.15	#995763	Orthodontic treatment 
EK8 (KaVo type)	\$29.85	Buy 4 @ \$27.15	#995764	Orthodontic treatment 
GC1 (KaVo type)	\$29.85	Buy 4 @ \$27.15	#995765	Supragingival and subgingival scaling 
GC2 (KaVo type)	\$29.85	Buy 4 @ \$27.15	#995766	Supragingival and subgingival scaling 
PC1 (KaVo type)	\$29.85	Buy 4 @ \$27.15	#995767	Subgingival Scaling 



Note:
 EMS is a registered trademark of Electro Medical System S.A. Switzerland.
 SATELEC is a registered trademark of Satelec/Acteon Group France.
 NSK is a registered trademark of Nakanishi Inc. Japan.
 SIRONA is a registered trademark of Sirona Dental System.
 Woodpecker and DTE are registered trademarks of Guilin Woodpecker Medical Instrument China.

PERIODONTAL					
	Regular Price per pc	Special Price per pc	Code		Purpose
P1 (Woodpecker, EMS type)	\$13.65	Buy 4 @ \$12.35	#995618		Periodontal Scaling
PD1 (DTE,SATELEC,NSK type)	\$13.65	Buy 4 @ \$12.35	#995619		Periodontal Scaling
PS1 (SIRONA type)	\$13.65	Buy 4 @ \$12.35	#995620		Periodontal Scaling
P3 (Woodpecker, EMS type)	\$13.65	Buy 4 @ \$12.35	#995621		Periodontal Scaling
PD3 (DTE,SATELEC,NSK type)	\$13.65	Buy 4 @ \$12.35	#995622		Periodontal Scaling
PS3 (SIRONA type)	\$13.65	Buy 4 @ \$12.35	#995623		Periodontal Scaling
P4 (Woodpecker, EMS type)	\$13.65	Buy 4 @ \$12.35	#995624		Periodontal Scaling
PD4 (DTE,SATELEC,NSK type)	\$13.65	Buy 4 @ \$12.35	#995625		Periodontal Scaling
PS4 (SIRONA type)	\$22.15	Buy 4 @ \$19.95	#995626		Periodontal Scaling
P3D (Woodpecker, EMS type)	\$22.15	Buy 4 @ \$19.95	#995627		Diamond-coated. Smoothing restoration overhangs and debride in-depth root
PD3D (DTE,SATELEC,NSK type)	\$22.15	Buy 4 @ \$19.95	#995628		Diamond-coated. Smoothing restoration overhangs and debride in-depth root
PS3D (SIRONA type)	\$22.15	Buy 4 @ \$19.95	#995629		Diamond-coated. Smoothing restoration overhangs and debride in-depth root
P2L (Woodpecker, EMS type)	\$22.15	Buy 4 @ \$19.95	#995633		Periodontal Scaling
PD2L (DTE,SATELEC,NSK type)	\$22.15	Buy 4 @ \$19.95	#995634		Periodontal Scaling
P2R (Woodpecker, EMS type)	\$22.15	Buy 4 @ \$19.95	#995635		Periodontal Scaling



Note:
 EMS is a registered trademark of Electro Medical System S.A. Switzerland.
 SATELEC is a registered trademark of Satelec/Acteon Group France.
 NSK is a registered trademark of Nakanishi Inc. Japan.
 SIRONA is a registered trademark of Sirona Dental System.
 Woodpecker and DTE are registered trademarks of Guilin Woodpecker Medical Instrument China.

PERIODONTAL					
	Regular Price per pc	Special Price per pc	Code		Purpose
PD2R (DTE,SATELEC,NSK type)	\$22.15	Buy 4 @ \$19.95	#995636		Periodontal Scaling
P2LD (Woodpecker, EMS type)	\$25.45	Buy 4 @ \$23.15	#995637		Periodontal Scaling
PD2LD (DTE,SATELEC,NSK type)	\$25.45	Buy 4 @ \$23.15	#995638		Periodontal Scaling
P2RD (Woodpecker, EMS type)	\$25.45	Buy 4 @ \$23.15	#995639		Periodontal Scaling
PD2RD (DTE,SATELEC,NSK type)	\$25.45	Buy 4 @ \$23.15	#995640		Periodontal Scaling

C & B					
	Regular Price per pc	Special Price per pc	Code		Purpose
G7 (Woodpecker, EMS type)	\$13.65	Buy 4 @ \$12.45	#995641		Crown Removal
GD7 (DTE,SATELEC,NSK type)	\$13.65	Buy 4 @ \$12.45	#995642		Crown Removal
GS7 (SIRONA type)	\$13.65	Buy 4 @ \$12.45	#995643		Crown Removal
G8 (Woodpecker, EMS type)	\$13.65	Buy 4 @ \$12.45	#995644		Crown Removal with irrigation
GD8 (DTE,SATELEC,NSK type)	\$13.65	Buy 4 @ \$12.45	#995645		Crown Removal with irrigation
GS8 (SIRONA type)	\$13.65	Buy 4 @ \$12.45	#995646		Crown Removal with irrigation

SCALING					
	Regular Price per pc	Special Price per pc	Code		Purpose
P50L (DTE PT3 unit only)	\$25.45	Buy 4 @ \$23.15	#995798		Supragingival Scaling
P50R (DTE PT3 unit only)	\$25.45	Buy 4 @ \$23.15	#995799		Supragingival Scaling
P52 (DTE PT3 unit only)	\$25.45	Buy 4 @ \$23.15	#995800		Supragingival Scaling
P56 (DTE PT3 unit only)	\$25.45	Buy 4 @ \$23.15	#995801		Supragingival Scaling
P59 (DTE PT3 unit only)	\$25.45	Buy 4 @ \$23.15	#995802		Supragingival Scaling



Note:
 EMS is a registered trademark of Electro Medical System S.A. Switzerland.
 SATELEC is a registered trademark of Satelec/Acteon Group France.
 NSK is a registered trademark of Nakanishi Inc. Japan.
 SIRONA is a registered trademark of Sirona Dental System.
 Woodpecker and DTE are registered trademarks of Guilin Woodpecker Medical Instrument China.

CAVITY PREPARATION				
	Regular Price per pc	Special Price per pc	Code	Purpose
SB1 (Woodpecker, EMS type)	\$25.45	Buy 4 @ \$23.15	#995647	For occlusal surface and cervical margins preparation
SBD1 (DTE,SATELEC,NSK type)	\$25.45	Buy 4 @ \$23.15	#995648	For occlusal surface and cervical margins preparation
SB2 (Woodpecker, EMS type)	\$25.45	Buy 4 @ \$23.15	#995650	Removes caries teeth without damaging neighbouring teeth
SBD2 (DTE,SATELEC,NSK type)	\$25.45	Buy 4 @ \$23.15	#995651	Removes caries teeth without damaging neighbouring teeth
SB3 (Woodpecker, EMS type)	\$25.45	Buy 4 @ \$23.15	#995653	Removes caries teeth without damaging neighbouring teeth
SBD3 (DTE,SATELEC,NSK type)	\$25.45	Buy 4 @ \$23.15	#995654	Removes caries teeth without damaging neighbouring teeth
SBL (Woodpecker, EMS type)	\$25.45	Buy 4 @ \$23.15	#995656	Half ball diamond tip. Set 45° to the left, to remove caries teeth without damaging
SBDL (DTE,SATELEC,NSK type)	\$25.45	Buy 4 @ \$23.15	#995657	Half ball diamond tip. Set 45° to the left, to remove caries teeth without damaging
SBR (Woodpecker, EMS type)	\$25.45	Buy 4 @ \$23.15	#995659	Half ball diamond tip. Set 45° to the left, to remove caries teeth without damaging
SBDR (DTE,SATELEC,NSK type)	\$25.45	Buy 4 @ \$23.15	#995660	Half ball diamond tip. Set 45° to the left, to remove caries teeth without damaging

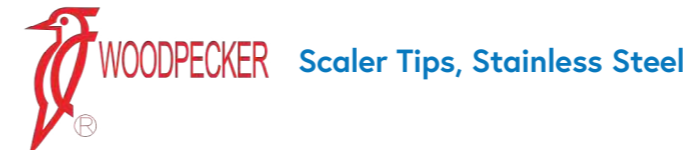

Note:
 EMS is a registered trademark of Electro Medical System S.A. Switzerland.
 SATELEC is a registered trademark of Satelec/Acteon Group France.
 NSK is a registered trademark of Nakanishi Inc. Japan.
 SIRONA is a registered trademark of Sirona Dental System.
 Woodpecker and DTE are registered trademarks of Guilin Woodpecker Medical Instrument China.

ENDO				
	Regular Price per pc	Special Price per pc	Code	Purpose
E1 (Woodpecker, EMS type)	\$18.35	Buy 4 @ \$16.65	#995662	120° endo holder, for root canal cleaning
ED1 (DTE,SATELEC,NSK type)	\$18.35	Buy 4 @ \$16.65	#995663	120° endo holder, for root canal cleaning
ES1 (SIRONA type)	\$18.35	Buy 4 @ \$16.65	#995664	120° endo holder, for root canal cleaning
E2 (Woodpecker, EMS type)	\$18.35	Buy 4 @ \$16.65	#995665	95° endo holder, for root canal cleaning
ED2 (DTE,SATELEC,NSK type)	\$18.35	Buy 4 @ \$16.65	#995666	95° endo holder, for root canal cleaning
ES2 (SIRONA type)	\$18.35	Buy 4 @ \$16.65	#995667	95° endo holder, for root canal cleaning
E3 (Woodpecker, EMS type)	\$18.35	Buy 4 @ \$16.65	#995668	For lateral thermal condensation of gutta-percha
ED3 (DTE,SATELEC,NSK type)	\$18.35	Buy 4 @ \$16.65	#995669	For lateral thermal condensation of gutta-percha
ES3 (SIRONA type)	\$18.35	Buy 4 @ \$16.65	#995670	For lateral thermal condensation of gutta-percha
E3D (Woodpecker, EMS type)	\$22.15	Buy 4 @ \$19.95	#995671	Diamond-coated. For removal of the calcification and filling material of pulp cavity
ED3D (DTE,SATELEC,NSK type)	\$22.15	Buy 4 @ \$19.95	#995672	Diamond-coated. For removal of the calcification and filling material of pulp cavity
ES3D (SIRONA type)	\$22.15	Buy 4 @ \$19.95	#995673	Diamond-coated. For removal of the calcification and filling material of pulp cavity
P4D (Woodpecker, EMS type)	\$22.15	Buy 4 @ \$19.95	#995674	Diamond-coated. For removal of calcification in the coronal third of roots
PD4D (DTE,SATELEC,NSK type)	\$22.15	Buy 4 @ \$19.95	#995675	Diamond-coated. For removal of calcification in the coronal third of roots
PS4D (SIRONA type)	\$22.15	Buy 4 @ \$19.95	#995676	Diamond-coated. For removal of calcification in the coronal third of roots
E10 (Woodpecker, EMS type)	\$25.45	Buy 4 @ \$23.15	#995677	For root canal treatment
ED10 (DTE,SATELEC,NSK type)	\$25.45	Buy 4 @ \$23.15	#995678	For root canal treatment
ES10 (SIRONA type)	\$25.45	Buy 4 @ \$23.15	#995679	For root canal treatment



Scaler Tips, Stainless Steel

Note:
 EMS is a registered trademark of Electro Medical System S.A. Switzerland.
 SATELEC is a registered trademark of Satelec/Acteon Group France.
 NSK is a registered trademark of Nakanishi Inc. Japan.
 SIRONA is a registered trademark of Sirona Dental System.
 Woodpecker and DTE are registered trademarks of Guilin Woodpecker Medical Instrument China.

ENDO				
	Regular Price per pc	Special Price per pc	Code	Purpose
E10D (Woodpecker, EMS type)	\$25.45	Buy 4 @ \$23.15	#995680	Used for root canal retrogression, efficient root apical polishing
ED10D (DTE,SATELEC,NSK type)	\$25.45	Buy 4 @ \$23.15	#995681	Used for root canal retrogression, efficient root apical polishing
E11 (Woodpecker, EMS type)	\$25.45	Buy 4 @ \$23.15	#995682	For root canal treatment
ED11 (DTE,SATELEC,NSK type)	\$25.45	Buy 4 @ \$23.15	#995683	For root canal treatment
ES11 (SIRONA type)	\$25.45	Buy 4 @ \$23.15	#995684	For root canal treatment
E11D (Woodpecker, EMS type)	\$25.45	Buy 4 @ \$23.15	#995685	Used for root canal retrogression, efficient root apical polishing
ED11D (DTE,SATELEC,NSK type)	\$25.45	Buy 4 @ \$23.15	#995686	Used for root canal retrogression, efficient root apical polishing
E14 (Woodpecker, EMS type)	\$25.45	Buy 4 @ \$23.15	#995687	For removal of obstructions and broken instruments in the root canal, with irrigation
ED14 (DTE,SATELEC,NSK type)	\$25.45	Buy 4 @ \$23.15	#995688	For removal of obstructions and broken instruments in the root canal, with irrigation
ES14 (SIRONA type)	\$25.45	Buy 4 @ \$23.15	#995689	For removal of obstructions and broken instruments in the root canal, with irrigation
E15 (Woodpecker, EMS type)	\$25.45	Buy 4 @ \$23.15	#995690	For removal of root canal fillings and broken instruments in the coronal third, with irrigation
ED15 (DTE,SATELEC,NSK type)	\$25.45	Buy 4 @ \$23.15	#995691	For removal of root canal fillings and broken instruments in the coronal third, with irrigation
ES15 (SIRONA type)	\$25.45	Buy 4 @ \$23.15	#995692	For removal of root canal fillings and broken instruments in the coronal third, with irrigation
E4 (Woodpecker, EMS type)	\$25.45	Buy 4 @ \$23.15	#995693	For removal of obstructions and broken instruments in the root canal
ED4 (DTE,SATELEC,NSK type)	\$25.45	Buy 4 @ \$23.15	#995694	For removal of obstructions and broken instruments in the root canal
ES4 (SIRONA type)	\$25.45	Buy 4 @ \$23.15	#995695	For removal of obstructions and broken instruments in the root canal



Scaler Tips, Stainless Steel

Note:
 EMS is a registered trademark of Electro Medical System S.A. Switzerland.
 SATELEC is a registered trademark of Satelec/Acteon Group France.
 NSK is a registered trademark of Nakanishi Inc. Japan.
 SIRONA is a registered trademark of Sirona Dental System.
 Woodpecker and DTE are registered trademarks of Guilin Woodpecker Medical Instrument China.

ENDO				
	Regular Price per pc	Special Price per pc	Code	Purpose
E4D (Woodpecker, EMS type)	\$25.45	Buy 4 @ \$23.15	#995696	Diamond-coated. For retreatments and removal of hard materials
ED4D (DTE,SATELEC,NSK type)	\$25.45	Buy 4 @ \$23.15	#995697	Diamond-coated. For retreatments and removal of hard materials
E5 (Woodpecker, EMS type)	\$25.45	Buy 4 @ \$23.15	#995698	For removal of root canal fillings and broken instruments in the coronal third
ED5 (DTE,SATELEC,NSK type)	\$25.45	Buy 4 @ \$23.15	#995699	For removal of root canal fillings and broken instruments in the coronal third
ES5 (SIRONA type)	\$25.45	Buy 4 @ \$23.15	#995700	For removal of root canal fillings and broken instruments in the coronal third
E5D (Woodpecker, EMS type)	\$25.45	Buy 4 @ \$23.15	#995701	Diamond-coated. For removal of dental overhangs in the pulp chamber
ED5D (DTE,SATELEC,NSK type)	\$25.45	Buy 4 @ \$23.15	#995702	Diamond-coated. For removal of dental overhangs in the pulp chamber
E8 (Woodpecker, EMS type)	\$22.15	Buy 4 @ \$19.95	#995703	Bur holder, used to expand root canal and grind teeth
ED8 (DTE,SATELEC,NSK type)	\$22.15	Buy 4 @ \$19.95	#995704	Bur holder, used to expand root canal and grind teeth
ES8 (SIRONA type)	\$22.15	Buy 4 @ \$19.95	#995705	Bur holder, used to expand root canal and grind teeth
E9 (Woodpecker, EMS type)	\$22.15	Buy 4 @ \$19.95	#995706	Bur holder, used to expand root canal and grind teeth
ED9 (DTE,SATELEC,NSK type)	\$22.15	Buy 4 @ \$19.95	#995707	Bur holder, used to expand root canal and grind teeth



**Scaler Tips, Stainless Steel
(TITANIUM COATING)**

Note:
EMS is a registered trademark of Electro Medical System S.A. Switzerland.
SATELEC is a registered trademark of Satelec/Acteon Group France.
NSK is a registered trademark of Nakanishi Inc. Japan.
Woodpecker and DTE are registered trademarks of Guilin Woodpecker Medical Instrument China.
Amdent is a registered trademark of Amdent Sweden.

SCALING					
	Regular Price per pc	Special Price per pc	Code		Purpose
A1T (Amdent type)	\$22.15	Buy 4 @ \$19.95	#995710		Supragingival Scaling
A2T (Amdent type)	\$22.15	Buy 4 @ \$19.95	#995711		Supragingival Scaling
G1T (Woodpecker, EMS type)	\$22.15	Buy 4 @ \$19.95	#995712		Supragingival Scaling
GDT (DTE,SATELEC,NSK type)	\$22.15	Buy 4 @ \$19.95	#995713		Supragingival Scaling
G2T (Woodpecker, EMS type)	\$22.15	Buy 4 @ \$19.95	#995714		Supragingival Scaling
GD2T (DTE,SATELEC,NSK type)	\$22.15	Buy 4 @ \$19.95	#995715		Supragingival Scaling
G3T (Woodpecker, EMS type)	\$12.45	Buy 4 @ \$11.35	#995716		Supragingival Scaling
GD3T (DTE,SATELEC,NSK type)	\$12.45	Buy 4 @ \$11.35	#995717		Supragingival Scaling
G4T (Woodpecker, EMS type)	\$12.45	Buy 4 @ \$11.35	#995718		Supragingival Scaling
GD4T (DTE,SATELEC,NSK type)	\$12.45	Buy 4 @ \$11.35	#995719		Supragingival Scaling
G5T (Woodpecker, EMS type)	\$12.45	Buy 4 @ \$11.35	#995720		Supragingival Scaling
GD5T (DTE,SATELEC,NSK type)	\$12.45	Buy 4 @ \$11.35	#995721		Supragingival Scaling
G6T (Woodpecker, EMS type)	\$12.45	Buy 4 @ \$11.35	#995722		Supragingival Scaling
GD6T (DTE,SATELEC,NSK type)	\$12.45	Buy 4 @ \$11.35	#995723		Supragingival Scaling



**Scaler Tips, Stainless Steel
(TITANIUM COATING)**

Note:
EMS is a registered trademark of Electro Medical System S.A. Switzerland.
SATELEC is a registered trademark of Satelec/Acteon Group France.
NSK is a registered trademark of Nakanishi Inc. Japan.
Woodpecker and DTE are registered trademarks of Guilin Woodpecker Medical Instrument China.

C & B					
	Regular Price per pc	Special Price per pc	Code		Purpose
G7T (Woodpecker, EMS type)	\$14.65	Buy 4 @ \$13.35	#995724		Crown removal
GD7T (DTE,SATELEC,NSK type)	\$14.65	Buy 4 @ \$13.35	#995725		Crown removal
G8T (Woodpecker, EMS type)	\$14.65	Buy 4 @ \$13.35	#995726		Crown Removal with irrigation
GD8T (DTE,SATELEC,NSK type)	\$14.65	Buy 4 @ \$13.35	#995727		Crown Removal with irrigation

PERIODONTAL					
	Regular Price per pc	Special Price per pc	Code		Purpose
P1T (Woodpecker, EMS type)	\$14.65	Buy 4 @ \$13.35	#995728		Periodontal Scaling
PD1T (DTE,SATELEC,NSK type)	\$14.65	Buy 4 @ \$13.35	#995729		Periodontal Scaling
P3T (Woodpecker, EMS type)	\$14.65	Buy 4 @ \$13.35	#995730		Periodontal Scaling
PD3T (DTE,SATELEC,NSK type)	\$14.65	Buy 4 @ \$13.35	#995731		Periodontal Scaling
P4T (Woodpecker, EMS type)	\$14.65	Buy 4 @ \$13.35	#995732		Periodontal Scaling
PD4T (DTE,SATELEC,NSK type)	\$14.65	Buy 4 @ \$13.35	#995733		Periodontal Scaling
P2LT (Woodpecker, EMS type)	\$14.65	Buy 4 @ \$13.35	#995734		Periodontal Scaling
PD2LT (DTE,SATELEC,NSK type)	\$14.65	Buy 4 @ \$13.35	#995735		Periodontal Scaling
P2RT (Woodpecker, EMS type)	\$14.65	Buy 4 @ \$13.35	#995736		Periodontal Scaling
PD2RT (DTE,SATELEC,NSK type)	\$14.65	Buy 4 @ \$13.35	#995737		Periodontal Scaling



**Scaler Tips, Stainless Steel
(TITANIUM COATING)**

Note:
EMS is a registered trademark of Electro Medical System S.A. Switzerland.
SATELEC is a registered trademark of Satelec/Acteon Group France.
NSK is a registered trademark of Nakanishi Inc. Japan.
Woodpecker and DTE are registered trademarks of Guilin Woodpecker Medical Instrument China.
Amdent is a registered trademark of Amdent Sweden.

	ENDO		Code	Image	Purpose
	Regular Price per pc	Special Price per pc			
E1T (Woodpecker, EMS type)	\$22.15	Buy 4 @ \$19.95	#995738		120° endo holder, for root canal cleaning
ED1T (DTE,SATELEC,NSK type)	\$22.15	Buy 4 @ \$19.95	#995739		120° endo holder, for root canal cleaning
E2T (Woodpecker, EMS type)	\$22.15	Buy 4 @ \$19.95	#995740		95° endo holder, for root canal cleaning
ED2T (DTE,SATELEC,NSK type)	\$22.15	Buy 4 @ \$19.95	#995741		95° endo holder, for root canal cleaning
E3T (Woodpecker, EMS type)	\$22.15	Buy 4 @ \$19.95	#995742		For lateral thermal condensation of gutta-percha
ED3T (DTE,SATELEC,NSK type)	\$22.15	Buy 4 @ \$19.95	#995743		For lateral thermal condensation of gutta-percha
E4T (Woodpecker, EMS type)	\$28.65	Buy 4 @ \$25.95	#995744		For removal of obstructions and broken instruments in the root canal
ED4T (DTE,SATELEC,NSK type)	\$28.65	Buy 4 @ \$25.95	#995745		For removal of obstructions and broken instruments in the root canal
E5T (Woodpecker, EMS type)	\$28.65	Buy 4 @ \$25.95	#995746		For removal of root canal fillings and broken instruments in the coronal third
ED5T (DTE,SATELEC,NSK type)	\$28.65	Buy 4 @ \$25.95	#995747		For removal of root canal fillings and broken instruments in the coronal third
E8T (Woodpecker, EMS type)	\$25.45	Buy 4 @ \$23.15	#995748		Bur holder, used to expand root canal and grind teeth
ED8T (DTE,SATELEC,NSK type)	\$25.45	Buy 4 @ \$23.15	#995749		Bur holder, used to expand root canal and grind teeth
E9T (Woodpecker, EMS type)	\$25.45	Buy 4 @ \$23.15	#995750		Bur holder, used to expand root canal and grind teeth
ED9T (DTE,SATELEC,NSK type)	\$25.45	Buy 4 @ \$23.15	#995751		Bur holder, used to expand root canal and grind teeth
E10T (Woodpecker, EMS type)	\$25.45	Buy 4 @ \$23.15	#995752		For root canal treatment
ED10T (DTE,SATELEC,NSK type)	\$25.45	Buy 4 @ \$23.15	#995753		For root canal treatment



**Scaler Tips, Stainless Steel
(TITANIUM COATING)**

Note:
EMS is a registered trademark of Electro Medical System S.A. Switzerland.
SATELEC is a registered trademark of Satelec/Acteon Group France.
NSK is a registered trademark of Nakanishi Inc. Japan.
Woodpecker and DTE are registered trademarks of Guilin Woodpecker Medical Instrument China.
Mectron is a registered trademark of Mectron S.P.A. Italy.

	ENDO		Code	Image	Purpose
	Regular Price per pc	Special Price per pc			
E11T (Woodpecker, EMS type)	\$25.45	Buy 4 @ \$23.15	#995754		For root canal treatment
ED11T (DTE,SATELEC,NSK type)	\$25.45	Buy 4 @ \$23.15	#995755		For root canal treatment
UE1 (Woodpecker, Mectron type)	\$105.95	Buy 4 @ \$96.95	#995794		Diamond-coated. For apical root debridement *Diamond grit 40um
UE2 (Woodpecker, Mectron type)	\$105.95	Buy 4 @ \$96.95	#995795		For gentle apical root debridement
UE3 (Woodpecker, Mectron type)	\$105.95	Buy 4 @ \$96.95	#995796		Diamond-coated. For apical root debridement *Diamond grit 40um
UE4 (Woodpecker, Mectron type)	\$105.95	Buy 4 @ \$96.95	#995797		For gentle apical root debridement

	BONE SURGERY		Code	Image	Purpose
	Regular Price per pc	Special Price per pc			
US1 (Woodpecker, Mectron type)	\$105.95	Buy 4 @ \$96.95	#995768		For osteotomy
US1L (Woodpecker, Mectron type)	\$105.95	Buy 4 @ \$96.95	#995769		For osteotomy
US1R (Woodpecker, Mectron type)	\$105.95	Buy 4 @ \$96.95	#995770		For osteotomy
US2 (Woodpecker, Mectron type)	\$105.95	Buy 4 @ \$96.95	#995771		For osteotomy
US3 (Woodpecker, Mectron type)	\$105.95	Buy 4 @ \$96.95	#995772		For precise osteotomy in thin/narrow regions
US4 (Woodpecker, Mectron type)	\$105.95	Buy 4 @ \$96.95	#995773		For bone chip harvesting and crown lengthening
US5 (Woodpecker, Mectron type)	\$105.95	Buy 4 @ \$96.95	#995774		For bone chip harvesting and bone modelling
US6 (Woodpecker, Mectron type)	\$105.95	Buy 4 @ \$96.95	#995775		For precise osteotomy



**Scaler Tips, Stainless Steel
(TITANIUM COATING)**

Note:
Woodpecker is a registered trademarks of Guilin Woodpecker Medical Instrument China.
Mectron is a registered trademark of Mectron S.P.A. Italy.

SINUS LIFT SURGERY				
	Regular Price per pc	Special Price per pc	Code	Purpose
UL1 (Woodpecker, Mectron type)	\$105.95	Buy 4 @ \$96.95	#995776	For peeling of the sinus membrane
UL2 (Woodpecker, Mectron type)	\$105.95	Buy 4 @ \$96.95	#995777	For peeling of the sinus membrane
UL3 (Woodpecker, Mectron type)	\$105.95	Buy 4 @ \$96.95	#995778	Diamond-coated. Non-traumatic bone cutting on thin bone region
UL4 (Woodpecker, Mectron type)	\$105.95	Buy 4 @ \$96.95	#995779	For micrometric osteotomy near soft tissue
UL5 (Woodpecker, Mectron type)	\$105.95	Buy 4 @ \$96.95	#995780	For peeling of the sinus membrane (95° angle)

IMPLANTATION				
	Regular Price per pc	Special Price per pc	Code	Purpose
UI1 (Woodpecker, Mectron type)	\$105.95	Buy 4 @ \$96.95	#995781	For implants with tip ball Ø1.6mm
UI2 (Woodpecker, Mectron type)	\$105.95	Buy 4 @ \$96.95	#995782	For implants with tip ball Ø2.0mm irrigation from tip point
UI7 (Woodpecker, Mectron type)	\$105.95	Buy 4 @ \$96.95	#995783	Diamond-coated. Finalise the implant site and bone preparation *Diamond grit: 100um
UI8 (Woodpecker, Mectron type)	\$105.95	Buy 4 @ \$96.95	#995784	For implants, X-Long with tip Ø1.6mm
UI9 (Woodpecker, Mectron type)	\$105.95	Buy 4 @ \$96.95	#995785	For implants with tip ball Ø2.8mm



**Scaler Tips, Stainless Steel
(TITANIUM COATING)**

Note:
Woodpecker is a registered trademarks of Guilin Woodpecker Medical Instrument China.
Mectron is a registered trademark of Mectron S.P.A. Italy.

EXCEL CYMOSIS				
	Regular Price per pc	Special Price per pc	Code	Purpose
UC1 (Woodpecker, Mectron type)	\$105.95	Buy 4 @ \$96.95	#995786	For cutting ligaments, with minimal wound

PERIODONTAL SURGERY				
	Regular Price per pc	Special Price per pc	Code	Purpose
UP1 (Woodpecker, Mectron type)	\$97.25	Buy 4 @ \$88.45	#995787	For root scaling
UP2 (Woodpecker, Mectron type)	\$97.25	Buy 4 @ \$88.45	#995788	For root scaling
UP3 (Woodpecker, Mectron type)	\$97.25	Buy 4 @ \$88.45	#995789	For root scaling
UP4 (Woodpecker, Mectron type)	\$105.95	Buy 4 @ \$96.95	#995790	Diamond-coated. For root surface debridement and root planning *Diamond grit 40um
UP5 (Woodpecker, Mectron type)	\$105.95	Buy 4 @ \$96.95	#995791	For perio treatment
UP6 (Woodpecker, Mectron type)	\$105.95	Buy 4 @ \$96.95	#995792	Diamond-coated. For root preparation in perio surgery *Diamond grit 40um
UP7 (Woodpecker, Mectron type)	\$105.95	Buy 4 @ \$96.95	#995793	Diamond-coated. For bone remodeling and root canal enlargement *Diamond grit 40um

BeeSure
PROTECT & PRESERVE

EXCLUSIVELY DISTRIBUTED BY
NuMedical

Carbon footprint reduced by more than **25 tonnes!**

COMPACT packaging to reduce waste!

Over **60,000** trees planted!

EcoBee

EcoBee® is dedicated to providing affordable quality products whilst preserving the environment. EcoBee® partners with various organisations in their effort to protect and preserve the environment.

25th FOR NATURE
AMERICAN FORESTS
140 years of protecting & restoring forests
PLANET Bee FOUNDATION

NuMedical is proud to partner with EcoBee® to bring eco-friendly infection control solutions to dental professionals in Australia.



\$18.55 /box

FREE SAMPLES!

Available in HOT & NEW Promo! (PG 2)

Latex-Free

Beesure Black Nitrile Exam Gloves

Special Buy 10 @ \$17.50/box

X-Special Buy 40 @ \$16.85/box

200pcs/box

Gorgeous black nitrile gloves that not only look good but feel good! Soft and stretchy nitrile formulation with excellent tactile sensitivity. Super compact packaging reduces storage space. Latex-free and powder-free.

Size	Code	Colour
XS	BE1165	Black
S	BE1166	
M	BE1167	
L	BE1168	



\$17.85 /box

FREE SAMPLES!

Available in HOT & NEW Promo! (PG 2)

Latex-Free

Beesure Canyon Nitrile Exam Gloves

Special Buy 10 @ \$17.00/box

X-Special Buy 40 @ \$16.20/box

200pcs/box

Soft and stretchy nitrile formulation with excellent tactile sensitivity. Super compact packaging reduces storage space. Latex-free and powder-free.

Size	Code	Colour
XS	BE2915	Peach
S	BE2916	
M	BE2917	
L	BE2918	



\$21.85 /box

FREE SAMPLES!

Available in HOT & NEW Promo! (PG 2)

Latex-Free

Beesure Forest Nitrile Gloves

Special Buy 10 @ \$20.80/box

X-Special Buy 40 @ \$19.85/box

300pcs/box

Soft and stretchy nitrile formulation with excellent tactile sensitivity. Super compact packaging reduces storage space. Latex-free and powder-free.

Size	Code	Colour
XS	BE2945	Forest Green
S	BE2946	
M	BE2947	
L	BE2948	



\$20.95 /box

FREE SAMPLES!

Available in HOT & NEW Promo! (PG 2)

Latex-Free

Beesure Cloud Nitrile Exam Gloves

Special Buy 10 @ \$19.95/box

X-Special Buy 40 @ \$19.00/box

300pcs/box

Soft and stretchy nitrile formulation with excellent tactile sensitivity. Super compact packaging reduces storage space. Latex-free and powder-free.

Size	Code	Colour
XS	BE2935	White
S	BE2936	
M	BE2937	
L	BE2938	



\$16.85 /box

FREE SAMPLES!

Available in HOT & NEW Promo! (PG 2)

Beesure Latex Exam Gloves

Special Buy 10 @ \$8.00/box

X-Special Buy 40 @ \$7.65/box

100pcs/box

Smooth polymer interior coating for improved moist or dry donning. Full-hand micro-textured for optimal grip. Powder-free, chlorine-free and low protein content to minimise exposure to allergens and irritants.

Size	Code	Colour
XS	BE2815	Natural Latex
S	BE2816	
M	BE2817	
L	BE2818	



\$1.95 /pair

FREE SAMPLES!

Available in HOT & NEW Promo! (PG 2)

Beesure Latex Exam Gloves

Special Buy 10 pairs @ \$1.75/pair

X-Special Buy 50 pairs @ \$1.40/pair

Hand-specific fitted gloves for use in sterile environments. Smooth polymer interior coating for improved moist or dry donning. Full-hand micro-textured for optimal grip. Powder-free, chlorine-free and protein-rated to minimise exposure to allergens and irritants. Available in 5 sizes for the perfect fit.

Size	Code	Colour
6.0	BE3160	Natural Latex
6.5	BE3165	
7.0	BE3170	
7.5	BE3175	
8.0	BE3180	



\$16.85 /box

FREE SAMPLES!

Available in HOT & NEW Promo! (PG 3)

Beesure Dental Dams, 5" x 5"

Special Buy 4 @ \$15.35/box

52pcs/box

Powder-free rubber dams with low protein content to minimise exposure to allergens and irritants. Option of plain or mint-scented dams.

Code	Scent
BE102	Plain
BE105	Mint



\$16.85 /box

FREE SAMPLES!

Available in HOT & NEW Promo! (PG 3)

Beesure Dental Dams, 6" x 6"

Special Buy 4 @ \$15.35/box

36pcs/box

Powder-free rubber dams with low protein content to minimise exposure to allergens and irritants. Option of plain or mint-scented dams.

Code	Scent
BE112	Plain
BE115	Mint



\$6.75 each

Dental Dam Frame - Plastic

Special Buy 4 @ \$6.15 each

Unique design with strong grip and enhanced patient comfort. Autoclavable up to 135°C. Reusable.

Code	Colour
#990999	Blue

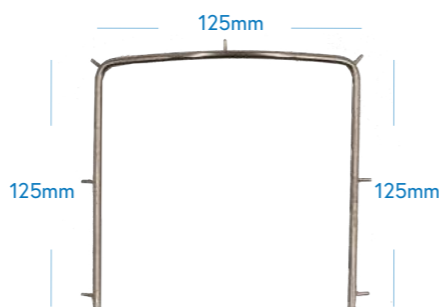

\$13.05 each

Dental Dam Frame - Steel

Special Buy 4 @ \$11.85 each

Made from high grade stainless steel. Autoclavable up to 135°C. Reusable.

Code
#991000



\$10.75 /box

FREE SAMPLES!

Available in HOT & NEW Promo! (PG 3)

Oatmeal

Happy Coats Latex Exam Gloves

Special Buy 10 @ \$10.20/box

X-Special Buy 40 @ \$9.75/box

100pcs/box

Pamper your hands with Colloidal Oatmeal Active Therapeutic System. Recognised by FDA as a skin protectant, ideal if you suffer from dry hands. Powder-free, full-textured.

Size	Code	Colour
XS	#990044	Light Green
S	#990045	
M	#990046	
L	#990047	



\$20.30 /box

FREE SAMPLES!

Available in HOT & NEW Promo! (PG 3)

Latex-Free

Oatmeal

Happy Coats Nitrile Exam Gloves

Special Buy 10 @ \$19.30/box

X-Special Buy 40 @ \$18.40/box

200pcs/box

Pamper your hands with Colloidal Oatmeal Active Therapeutic System. Recognised by FDA as a skin protectant, ideal if you suffer from dry hands. Latex-free and powder-free.

Size	Code	Colour
XS	#990056	Blue
S	#990057	
M	#990058	
L	#990059	



\$10.85 /box

FREE SAMPLES!

Available in HOT & NEW Promo! (PG 3)

Aloe Vera

Aloe Care Latex Exam Gloves

Special Buy 10 @ \$10.30/box

X-Special Buy 40 @ \$9.85/box

100pcs/box

Pamper your hands with Aloe Vera coated latex exam gloves to keep your hands soft and smooth all day long! Non-sterile, powder-free, full-textured and ambidextrous latex exam gloves.

Size	Code	Colour
XS	#990040	Natural Latex
S	#990041	
M	#990042	
L	#990043	



\$19.75 /box

Impression Syringes - Curved

Special Buy 4 @ \$17.95/box
50pcs/box

Disposable curved-tip impression syringes for easy application and to reach tight areas. Capacity: 5ml

Code	Colour
#991096	White



\$17.25 /box

Impression Syringes

Special Buy 4 @ \$15.65/box
50pcs/box

Tips can be bent to 45°. Ideal for a range of applications and suit all types of impression materials.

Code	Colour
#991098	White



\$16.45 each

Bite Registration Impression Tray, Quadrant

Special Buy 4 @ \$14.95 each
36pcs/box

Dual arch. Thin, loose webbing ensures an excellent bite registration. Disposable.

Code	Colour
#991115	Yellow



\$16.45 each

Bite Registration Impression Tray, Posterior

Special Buy 4 @ \$14.95 each
36pcs/box

Dual arch. Thin, loose webbing ensures an excellent bite registration. Disposable.

Code	Colour
#991116	Green



\$33.95 each

Cartridge Gun, 1:1 - 2:1

Special Buy 4 @ \$30.85 each

Temporary crown and bridge dispensing gun. Size: 1:1 - 2:1

Code	Colour
#991070	Grey



\$33.95 each

Cartridge Gun, 4:1 - 10:1

Special Buy 4 @ \$30.85 each

Temporary crown and bridge dispensing gun. Size: 4:1 - 10:1

Code	Colour
#991071	Grey



\$16.45 each

Bite Registration Impression Tray, Sideless Posterior

Special Buy 4 @ \$14.95 each
36pcs/box

Dual arch. Thin, loose webbing ensures an excellent bite registration. Disposable.

Code	Colour
#991117	White

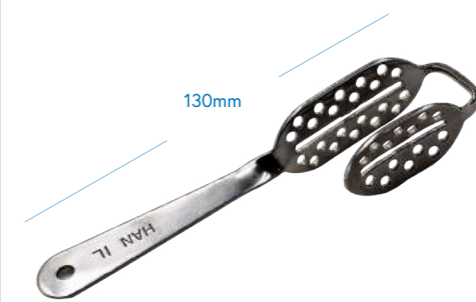

\$19.95 each

Check-Bite Impression Tray

Special Buy 4 @ \$17.95 each

Made from medical grade stainless steel. Used to register bite impressions. Autoclavable up to 135°. Size: 130mm (L)

Code	Colour
#991118	Stainless Steel



\$16.45 each

Bite Registration Impression Tray, Full Arch

Special Buy 4 @ \$14.95 each
24pcs/box

Dual arch. Thin, loose webbing ensures an excellent bite registration. Disposable.

Code	Colour
#991113	Blue



\$16.45 each

Bite Registration Impression Tray, Anterior

Special Buy 4 @ \$14.95 each
36pcs/box

Dual arch. Thin, loose webbing ensures an excellent bite registration. Disposable.

Code	Colour
#991114	Purple



\$24.35 /box

Wire Bite Tray

Special Buy 4 @ \$22.15/box
2pcs/box

Made from medical grade stainless steel. Used to register bite impressions. Autoclavable up to 135°C. Size: 150mm (L)

Code	Colour
#991123	Stainless Steel



\$3.25 /bag

Disposable Inserts for Wire Bite Tray

Special Buy 4 @ \$2.95/bag
50pcs/bag

Inserts for Wire Bite Tray (#991123).

Code	Colour
#991122	White

IMPRESSION



\$5.55 /bag

Upper Right/Lower Left
Upper Left/Lower Right

Anterior

Blue Impression Trays

Special Buy 4 @ \$5.05/bag

12pcs/bag

These are disposable impression trays made from a strong, rigid material to provide consistent and undistorted bite impressions. Uniquely designed through joint research with a dental university. Compatible with a wide range of impression materials with a unique perforation system to optimise flow and retention of materials.

Size	Code	Colour
XL Upper	#991146	Blue
XL Lower	#991147	Blue
L Upper	#991148	Blue
L Lower	#991149	Blue
M Upper	#991150	Blue
M Lower	#991151	Blue
S Upper	#991152	Blue
S Lower	#991153	Blue
Upper Right, Lower Left	#991154	Blue
Upper Left, Lower Right	#991155	Blue
Anterior	#991156	Blue

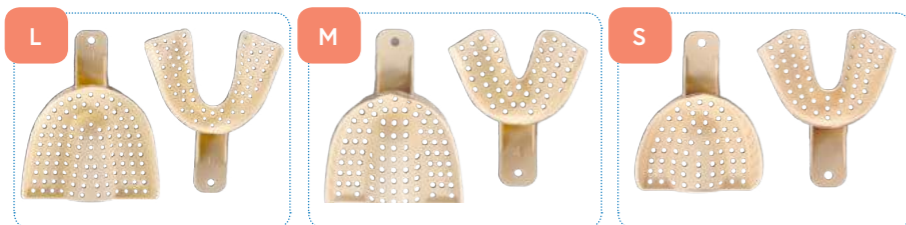

\$4.35 /bag

Upper Right/Lower Left
Upper Left/Lower Right

Anterior

Beige Impression Trays

Special Buy 4 @ \$3.95/bag

12pcs/bag

These are disposable impression trays made from a strong, rigid material to provide consistent and undistorted bite impressions. Compatible with a wide range of impression materials with a unique perforation system to optimise flow and retention of materials.

Size	Code	Colour
L Upper	#991106	Beige
L Lower	#991109	Beige
M Upper	#991105	Beige
M Lower	#991108	Beige
S Upper	#991104	Beige
S Lower	#991107	Beige
Upper Right, Lower Left	#991111	Beige
Upper Left, Lower Right	#991112	Beige
Anterior	#991110	Beige

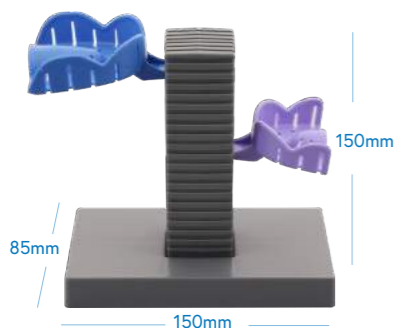

\$30.65 each

Impression trays not included.

Impression Tray Holder

Special Buy 4 @ \$27.85 each

This practical impression tray holder helps to set and dry impression materials safely and reduces the risk of deformation.

Size: 150mm (L) x 85mm (W) x 150mm (H)

Cleaning instructions:

Wipe with alcohol-based disinfectant solution.

Code	Colour
#991181	Grey

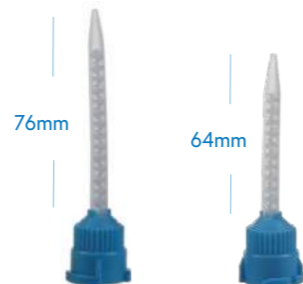

\$13.15 /bag

Mixing Tips, 1:1

Special Buy 4 @ \$11.95/bag

50pcs/bag

For light body, temporary crown and bridge impression materials. Dual curing resin post core, self-setting and self-curing temporary crown bridging materials. Ratio: 1:1. Single-use.

Size	Code	Colour
76mm	#991084	Blue & White
64mm	#991085	Blue & White

IMPRESSION



\$11.75 /bag

Impression Trays - Child XS

Special Buy 4 @ \$10.65/bag

25pcs/bag

These impression trays are designed with beveled perforation system to retain alginates better. Smooth rounded edges and ergonomically contoured for maximum patient comfort. Longer handle for easy handling.

Size	Code	Colour
Child XS Upper	#993409	Red
Child XS Lower	#993410	Red



\$11.75 /bag

Impression Trays - Child S

Special Buy 4 @ \$10.65/bag

25pcs/bag

These impression trays are designed with beveled perforation system to retain alginates better. Smooth rounded edges and ergonomically contoured for maximum patient comfort. Longer handle for easy handling.

Size	Code	Colour
Child S Upper	#993411	Orange
Child S Lower	#993412	Orange



\$11.75 /bag

Impression Trays - Child M

Special Buy 4 @ \$10.65/bag

25pcs/bag

These impression trays are designed with beveled perforation system to retain alginates better. Smooth rounded edges and ergonomically contoured for maximum patient comfort. Longer handle for easy handling.

Size	Code	Colour
Child M Upper	#993413	Blue
Child M Lower	#993414	Blue



\$11.75 /bag

Impression Trays - Adult S

Special Buy 4 @ \$10.65/bag

25pcs/bag

These impression trays are designed with beveled perforation system to retain alginates better. Smooth rounded edges and ergonomically contoured for maximum patient comfort. Longer handle for easy handling.

Size	Code	Colour
Adult S Upper	#993415	Green
Adult S Lower	#993416	Green

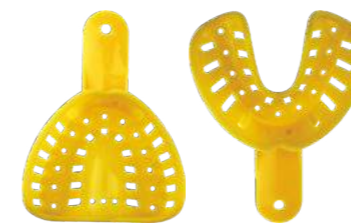

\$11.75 /bag

Impression Trays - Adult M

Special Buy 4 @ \$10.65/bag

25pcs/bag

These impression trays are designed with beveled perforation system to retain alginates better. Smooth rounded edges and ergonomically contoured for maximum patient comfort. Longer handle for easy handling.

Size	Code	Colour
Adult M Upper	#993417	Yellow
Adult M Lower	#993418	Yellow



\$11.75 /bag

Impression Trays - Adult L

Special Buy 4 @ \$10.65/bag

25pcs/bag

These impression trays are designed with beveled perforation system to retain alginates better. Smooth rounded edges and ergonomically contoured for maximum patient comfort. Longer handle for easy handling.

Size	Code	Colour
Adult L Upper	#993419	Purple
Adult L Lower	#993420	Purple

IMPRESSION

IMPRESSION

IMPRESSION

IMPRESSION

NuMedical

NuMedical

6.5mm 5.4mm 4.2mm



\$12.60 /bag

Mixing Tips - HP Type
Special Buy 4 @ \$11.45/bag
50pcs/bag

Size	Code	Colour
6.5mm	#991081	Blue
5.4mm	#991082	Pink
4.2mm	#991083	Yellow

Fits all HP cartridge systems. Disposable.



\$12.95 /bag

Mixing Tips 10:1
Special Buy 4 @ \$11.75/bag
50pcs/bag

Code	Colour
#991086	Blue / Orange

Mixing tips with orange core for use with all temporary crown and bridge material cartridges. Ratio: 10:1. Size: 77mm (L)



\$3.10 /bag

Dynamic Mixing Tips - Red
Special Buy 4 @ \$2.80/bag
10pcs/bag

Code	Colour
#991187	Red

Fits: 3M Pentamix Lite Mixer. Disposable.



\$4.95 /bag

Dynamic Mixing Tips - White
Special Buy 4 @ \$4.55/bag
10pcs/bag

Code	Colour
#991189	White

Fits: DMG MixStar - eMotion mixer. Disposable.



\$10.95 /bag

Intraoral Tips - White
Special Buy 4 @ \$9.95/bag
100pcs/bag

Code	Colour
#991089	White

Disposable white intraoral tips for 6.5mm and 5.4mm mixing tips.



\$10.95 /bag

Intraoral Tips - Yellow
Special Buy 4 @ \$9.95/bag
100pcs/bag

Code	Colour
#991088	Yellow

Disposable yellow intraoral tips for 4.2mm mixing tips.



\$4.95 /bag

Dynamic Mixing Tips - Yellow
Special Buy 4 @ \$4.55/bag
10pcs/bag

Code	Colour
#991190	Yellow

Fits: Heraeus Kulzer, GC, Huge, Muller-Omicron, Zhermack. Disposable.



\$3.20 each

Mixing Bowl - Large
Special Buy 4 @ \$2.90 each

Code	Colour
#991157	Dark Green

Ideal for mixing all types of materials. Made from non-stick medical-grade soft PVC. Size: 96mm (H) x 130mm (Diameter)



\$15.80 each

Intraoral Ribbon Tips
Special Buy 4 @ \$14.35/bag
100pcs/bag

Code	Colour
#991090	White

Disposable white intraoral tips for 6.5mm and 5.4mm mixing tips.



\$4.95 /bag

Dynamic Mixing Tips - Blue
Special Buy 4 @ \$4.55/bag
10pcs/bag

Code	Colour
#991188	Blue

Fits: Renfert Duomix 2 Dynamic Mixer. Disposable.

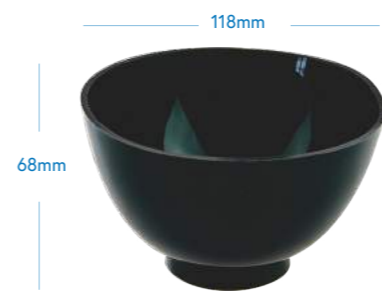

\$3.00 each

Mixing Bowl - Medium
Special Buy 4 @ \$2.70 each

Code	Colour
#991158	Dark Green

Ideal for mixing all types of materials. Made from non-stick medical-grade soft PVC. Size: 68mm (H) x 118mm (Diameter)

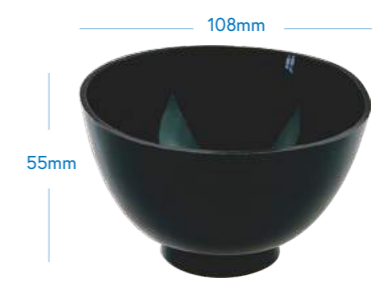

\$2.80 each

Mixing Bowl - Small
Special Buy 4 @ \$2.50 each

Code	Colour
#991159	Dark Green

Ideal for mixing all types of materials. Made from non-stick medical-grade soft PVC. Size: 55mm (H) x 108mm (Diameter)

IMPRESSION

IMPRESSION

IMPRESSION

IMPRESSION

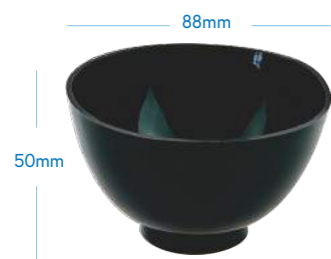

\$1.50 each

Mixing Bowl - Extra Small
Special Buy 4 @ \$1.35 each

Ideal for mixing all types of materials. Made from non-stick medical-grade soft PVC. Size: 50mm (H) x 88mm (Diameter)

Code	Colour
#991160	Dark Green



\$16.00 /bag

Disposable Mixing Bowls - Assorted
Special Buy 4 @ \$14.55/bag
12pcs/bag

Disposable mixing bowls in assorted colours (white, blue, yellow, pink, green and purple. Ideal for mixing all types of materials. Size: 82mm (H) x 125mm (Diameter)

Code	Colour
#991134	Assorted

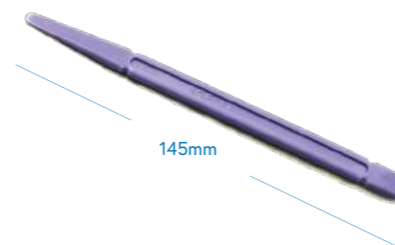

\$1.05 each

Autoclavable Mixing Spatula
Special Buy 4 @ \$0.95 each

Suits all types of mixing bowls and cups. Made from high grade flexible plastic. Autoclavable up to 135°C. Size: 145mm (L)

Code	Colour
#991137	Purple

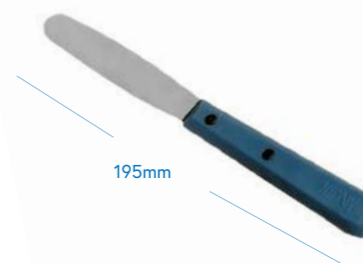

\$3.75 each

Autoclavable Alginate and Plaster Spatula
Special Buy 4 @ \$3.35 each

Suits all types of mixing bowls and cups. Made from medical grade stainless steel with easy grip blue handle. Autoclavable up to 135°C. Size: 195mm (L)

Code	Colour
#991127	Blue



\$5.35 /box

Silicone Mixing Bowls - A
Special Buy 4 @ \$4.85/box
2pcs/box

Ideal for mixing all types of materials. Made from non-stick medical-grade silicone. Autoclavable up to 135°C. Size: 41mm (H) x 42mm (Diameter)

Code	Colour
#990797	White



\$5.35 /box

Silicone Mixing Bowls - B
Special Buy 4 @ \$4.85/box
2pcs/box

Ideal for mixing all types of materials. Made from non-stick medical-grade silicone. Autoclavable up to 135°C. Size: 37mm (H) x 35mm (Diameter)

Code	Colour
#990798	White



\$10.30 each

Mixing Cups
Special Buy 4 @ \$9.35 each

Made from high grade plastic. Comes with lid. Autoclavable up to 135°C.

Size	Code	Colour
Large	#991136	Green
Small	#991135	Green

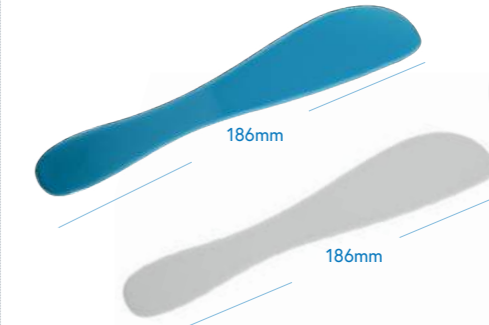

\$2.15 each

Autoclavable Alginate and Plaster Spatula
Special Buy 4 @ \$1.95 each

Designed to suit all types of mixing bowls and cups. Made from high grade plastic material that does not create scratches on any surface that it comes in contact with. Autoclavable up to 135°C. Size: 186mm (L)

Code	Colour
#991129	Grey
#991128	Blue



\$3.70 /box

Silicone Mixing Bowls - C
Special Buy 4 @ \$3.35/box
2pcs/box

Ideal for mixing all types of materials. Made from non-stick medical-grade silicone. Autoclavable up to 135°C. Size: 25mm (H) x 24mm (Diameter)

Code	Colour
#990799	White



\$3.70 /box

Silicone Mixing Bowls - D
Special Buy 4 @ \$3.35/box
2pcs/box

Ideal for mixing all types of materials. Made from non-stick medical-grade silicone. Autoclavable up to 135°C. Size: 22mm (H) x 30mm (Diameter)

Code	Colour
#990812	White



\$1.30 /bag

Disposable Mixing Spatulas
Special Buy 4 @ \$1.15/bag
20pcs/bag

Disposable mixing spatulas for mixing alginates, plasters, stones and resins. Size: 110mm (L)

Code	Colour
#991130	White



\$7.95 /bag

Disposable Mixing Spatulas - Assorted
Special Buy 4 @ \$7.25/bag
12pcs/bag

Disposable mixing spatulas for mixing alginates, plasters, stones and resins. Assorted colours of white, blue, yellow, pink, green and purple. Size: 186mm (L)

Code	Colour
#991131	Assorted

NuMedical



\$36.55 each

Butane gas not included.

Electronic Micro Torch

Special Buy 4 @ \$33.25 each

Cordless micro torch designed with multiple features; quick gas refill design, electric ignition, adjustable flame, continuous flame option. Autoclavable up to 135°C.

Important:

When in use, always point the nozzle away from your face, body and clothing. Do not exceed 30 minutes of continuous use. Ensure that the flame is completely turned off or extinguished after each use. Store torch in a dry cool place, away from heat and sunlight. Keep nozzle clean and dry from dust and particles. Butane gas is extremely flammable, handle with care.

Code	Colour
#990892	Teal
#990893	Pink
#990894	Green
#990895	Orange
#990896	Purple



\$45.50 each

Butane gas not included.

Multi-Purpose Micro Torch

Special Buy 4 @ \$41.35 each

Cordless lightweight micro torch designed with multiple features; quick gas refill design, Piezo ignition, adjustable flame. Autoclavable up to 135°C.

Important:

When in use, always point the nozzle away from your face, body and clothing. Do not exceed 30 minutes of continuous use. Ensure that the flame is completely turned off or extinguished after each use. Store torch in a dry cool place, away from heat and sunlight. Keep nozzle clean and dry from dust and particles. Butane gas is extremely flammable, handle with care.

Code	Colour
#990880	Black

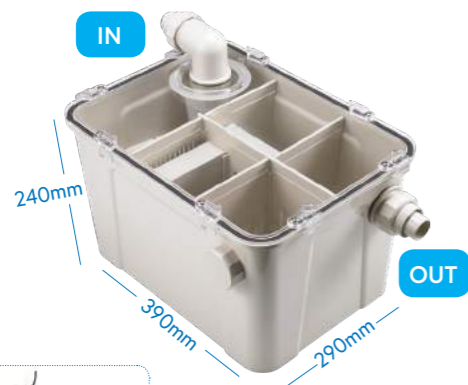

\$268.35 each

Plaster Trap Filter

Special Buy 4 @ \$243.95 each

This plaster trap can be easily installed under the sink to trap materials such as plasters, stones and resins from clogging the drainage system. It has a transparent snap-shut closing system with four chambers. Size: 390mm (L) x 290mm (W) x 240mm (H)

Code	Colour
#993247	Grey

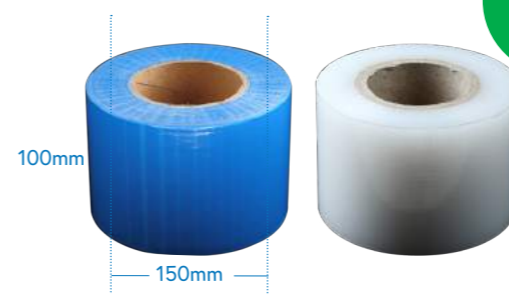

\$13.15 each

Barrier Film, 1200pcs

Special Buy 4 @ \$11.95 each

This is an infection control barrier with a removable tacky adhesive that does not leave behind any residue. Quick and easy to apply and remove. Each roll has 1200 pieces of single-use perforated 150mm (L) x 100mm (W) sheets.

Code	Colour
#992482	Blue
#992483	White

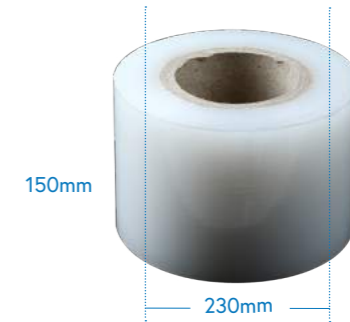

\$21.50 each

Barrier Film, 800pcs

Special Buy 4 @ \$19.55 each

This is an infection control barrier with a removable tacky adhesive that does not leave behind any residue. Quick and easy to apply and remove. Each roll has 800 pieces of single-use perforated 230mm (L) x 150mm (W) sheets.

Code	Colour
#992500	Clear

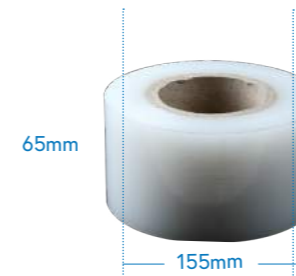

\$5.45 each

Barrier Film, 600pcs

Special Buy 4 @ \$4.95 each

This is an infection control barrier with a removable tacky adhesive that does not leave behind any residue. Quick and easy to apply and remove. Each roll has 600 pieces of single-use perforated 155mm (L) x 65mm (W) sheets.

Code	Colour
#992501	Clear



\$24.15 each

Barrier film not included.

Barrier Film Roll Dispenser

Special Buy 4 @ \$21.95 each

For easy dispensing of barrier film. Compatible with Barrier Film (1200pcs), #992482 and #992483.

Code	Colour
#992484	Clear



\$20.20 each

Tubing Sleeves Roll, 50mm

Special Buy 4 @ \$18.35 each

Effective infection control barrier for tubes, hoses and cables. Disposable. 366m per roll, 50mm (W).

Code	Colour
#992489	Clear

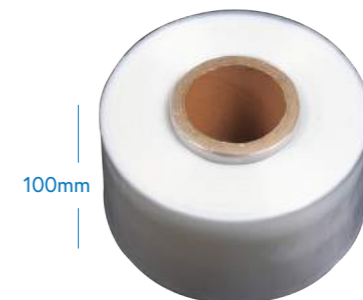

\$38.65 each

Tubing Sleeves Roll, 100mm

Special Buy 4 @ \$35.15 each

Effective infection control barrier for tubes, hoses and cables. Disposable. 366m per roll, 100mm (W).

Code	Colour
#992490	Clear



\$2.50 /box
FREE SAMPLES!

Tray Sleeves - Mini A
Special Buy 4 @ \$2.20/box
100pcs/box

Clear secure-fit plastic sleeves for mini trays to reduce the risks of cross-contamination. Also fits Size F trays. Single-use. Size: 265mm (L) x 190mm (W). See page 25 - 28 for our tray options.

Code	Colour
#992516	Clear



\$4.20 /box
FREE SAMPLES!

Tray Sleeves - Ritter B
Special Buy 4 @ \$3.80/box
100pcs/box

Clear secure-fit plastic sleeves for Ritter B trays to reduce the risks of cross-contamination. Single-use. Size: 355mm (L) x 265mm (W). See page 25 - 28 for our tray options.

Code	Colour
#992514	Clear



\$7.75 /box
FREE SAMPLES!

Curing Light Tip Sleeves
Special Buy 4 @ \$7.05/box
200pcs/box

Disposable clear plastic sleeves for curing lights to reduce the risks of cross-contamination and bacteria build-up.

Size	Code	Colour
20mm (Diameter)	#992495	Clear
25mm (Diameter)	#992496	Clear



\$3.50 /box
FREE SAMPLES!

Curing Light Sleeves - Pen Style
Special Buy 4 @ \$3.20/box
100pcs/box

Disposable clear plastic tip-to-handle sleeves for curing lights to reduce the risks of cross-contamination and bacteria build-up.

Tip Size	Total Length x Width	Code	Colour
40mm (L) x 27mm (W)	250mm (L) x 50mm (W)	#992582	Clear
55mm (L) x 26mm (W)	250mm (L) x 52mm (W)	#992583	Clear
40mm (L) x 30mm (W)	250mm (L) x 55mm (W)	#992584	Clear



\$4.95 /box
FREE SAMPLES!

Tray Sleeves - Weber E
Special Buy 4 @ \$4.50/box
100pcs/box

Clear secure-fit plastic sleeves for Weber trays to reduce the risks of cross-contamination. Also fits Size B trays. Single-use. Size: 405mm (L) x 295mm (W). See page 25 - 28 for our tray options.

Code	Colour
#992515	Clear



\$1.55 /box
FREE SAMPLES!

Handpiece and Pen Sleeves
Special Buy 4 @ \$1.40/box
100pcs/box

Disposable clear plastic sleeves for handpieces, jet polishers and ultrasonic scalers.

Size	Code	Speed	Colour
200mm (L) x 37mm (Diameter)	#992493	Low Speed	Clear
200mm (L) x 23mm (Diameter)	#992492	High Speed	Clear



Curing Light Sleeves - Curved Tip
100pcs/box

FREE SAMPLES!

Disposable clear plastic tip-to-handle sleeves for curing lights to reduce the risks of cross-contamination and bacteria build-up. Curved tip for a snug fit.

Size options:
M: 340mm (L) x 53mm (W) x 20mm (Diameter)
L: 340mm (L) x 85mm (W) x 20mm (Diameter)

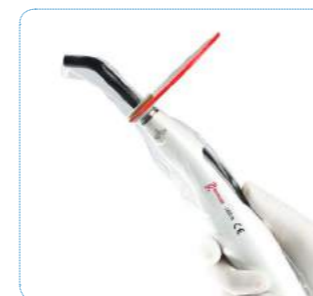

Size	Regular Price	Special Price	Code
M	\$4.00/box	Buy 4 @ \$3.50/box	#992497
L	\$5.00/box	Buy 4 @ \$4.40/box	#992498



Syringe/HVE Sleeves
Special Buy 4 @ \$1.20/box
100pcs/box

Disposable pre-punched clear plastic sleeves with adhesive tape for easy fit. Ideal for 3-way syringe, saliva ejectors, HVE, etc to reduce the risks of cross-contamination. Size: 250mm (L) x 60mm (W)



\$1.35 /box
FREE SAMPLES!

Type	Code	Colour
Without adhesive tape	#992486	Clear
With adhesive tape	#992487	Clear



Waste Container

A convenient, cost-effective and safe way to dispose of needles, sharps and other dental waste.

Size	Regular Price	Special Price	Code
1 Qt. (946ml)	\$5.50 each	Buy 4 @ \$5.00 each	#993833
4 Qt. (3784ml)	\$7.50 each	Buy 4 @ \$6.80 each	#993834
9 Qt. (7568ml)	\$11.00 each	Buy 4 @ \$10.00 each	#993835
18 Qt. (15136ml)	\$18.00 each	Buy 4 @ \$16.20 each	#993836



\$10.00 /box
FREE SAMPLES!

Dental Chair Sleeves - Half Body
Special Buy 4 @ \$9.00/box
50pcs/box

Clear half-body plastic sleeves for dental chairs to reduce the risks of cross-contamination. Disposable.
Size: 680mm (L) x 600mm (W)

Code	Colour
#992479	Clear



\$25.00 /box
FREE SAMPLES!

Dental Chair Sleeves - Full Body
Special Buy 4 @ \$22.50/box
50pcs/box

Clear full-body plastic sleeves for dental chairs to reduce the risks of cross-contamination. Disposable.
Size: 2020mm (L) x 730mm (W)

Code	Colour
#992481	Clear



FREE SAMPLES!

Disposable Bouffant Caps
100pcs/bag

Made from a non-woven, light weight, water-resistant and latex-free fabric.

Size	Regular Price	Special Price	Code
21"	\$6.10/bag	Buy 4 @ \$5.50/bag	#992171
24"	\$6.60/bag	Buy 4 @ \$6.00/bag	#992172



FREE SAMPLES!

Disposable Slip-On Caps
100pcs/bag

Cost-effective disposable slip-on caps.

Size	Regular Price	Special Price	Code
21"	\$5.50/bag	Buy 4 @ \$5.00/bag	#992158
24"	\$6.00/bag	Buy 4 @ \$5.40/bag	#992159



\$1.90 /box
FREE SAMPLES!

Light Handle Sleeves
Special Buy 4 @ \$1.70/box
100pcs/box

Clear plastic sleeves for light handle to reduce the risks of cross-contamination. Easy slip-on and does not fall off while in use.
Size: 100mm (L) x 145mm (W)

Type	Code	Colour
T-Shape	#992499	Clear
Rectangular	#992508	Clear



\$5.95 /box
FREE SAMPLES!

X-Ray Head Sleeves
Special Buy 4 @ \$5.35/box
50pcs/box

Universal clear plastic sleeves that fit most x-ray machines to reduce the risks of cross-contamination. Easy slip-on and does affect X-Ray performance.
Size: 660mm (L) x 380mm (W)

Code	Colour
#992513	Clear



\$12.65 /bag
FREE SAMPLES!

Surgeon Caps
Special Buy 4 @ \$11.50/box
100pcs/bag

Disposable surgeon caps with good heat and air ventilation. Adjustable for a comfortable fit. Light and latex-free.
Size: 120mm (L) x 640mm (W)

Code	Colour
#992185	Blue



FREE SAMPLES!

Non-Skid Shoe Covers
100pcs/bag

Made from spunbound polypropylene to prevent fluids and splashes from damaging your footwear. The seams are sewn for greater strength. Non-skid bottom ensures excellent traction. Latex-Free.

Size	Regular Price	Special Price	Code
38cm	\$14.00/bag	Buy 4 @ \$12.70/bag	#992150
40cm	\$14.80/bag	Buy 4 @ \$13.50/bag	#992151



Examination Gloves

See page 93 - 96 for our complete range of dental gloves.



Dental Dams

See page 95 for dental dams and frames.



\$34.25 /box

Sani Sleeves
Special Buy 4 @ \$31.15/box
10pcs/box

Effective barrier protection for handpieces and hoses. EO Gas sterilised. Single-Use only.
Size: 1500mm (L) x 55mm (W) x 30mm (Diameter)

Code
#992491

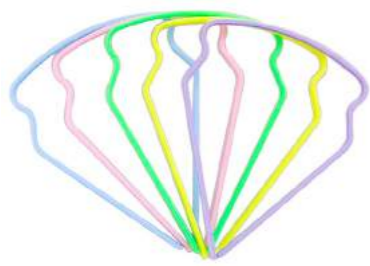

\$4.80 /bag

MUST BUY!

Eye Shields - Assorted
Special Buy 4 @ \$4.35/bag

Each bag comes with 5 frames in assorted colours (blue, pink, green, yellow and purple) and 25 clear lenses. Wrap around design for both side and front eye protection. Frames are autoclavable up to 135°C. Lens can be disposed or replaced.



Code	Colour
#992374	Assorted



\$4.80 /bag

MUST BUY!

Eye Shields - Pink
Special Buy 4 @ \$4.35/bag

Each bag comes with five pink frames and 25 clear lenses. Wrap around design for both side and front eye protection. Frames are autoclavable up to 135°C. Lens can be disposed or replaced.



Code	Colour
#992375	Pink



\$2.20 /bag

Ultra Light Eye Shield
Special Buy 4 @ \$2.00/bag

Ultra light eye shields provide excellent eye protection. Elegantly designed with ultimate comfort. Each bag comes with 1 frame and 10 clear lenses. Frames are autoclavable up to 135°C. Lens can be disposed or replaced.



Code	Colour
#992386	White
#992387	Yellow
#992388	Blue
#992389	Purple
#992390	Pink
#992391	Green



\$9.50 /bag

Ultra Light Refill Lenses
Special Buy 4 @ \$8.65/bag
100pcs/bag

Optical-grade lenses for Ultra Light Eye Shields. Disposable.

Code	Colour
#992393	Clear
#992394	Orange



\$7.20 /bag

Refill Lenses
Special Buy 4 @ \$6.55/bag
100pcs/bag

Optical-grade lenses for Eye Shields. Compatible with #992374 and #992375. Disposable.

Code	Colour
#994046	Clear
#994048	Orange



\$12.95 /bag

Refill Lenses, Anti-Fog
Special Buy 4 @ \$11.75/bag
100pcs/bag

Optical-grade anti-fog lenses for Eye Shields. Compatible with #992374 and #992375. Disposable.

Code	Colour
#992376	Clear



\$3.60 /bag

Ultra Light Full-Face Shield
Special Buy 4 @ \$3.20/bag

Ultra light full-face shields provide excellent full-face protection. Elegantly designed with ultimate comfort. Each bag comes with 1 frame and 10 clear lenses. Frames are autoclavable up to 135°C. Face lens can be disposed or replaced. Size: 220mm x 170mm



Code	Colour
#992377	White
#992378	Yellow
#992379	Blue
#992380	Purple
#992381	Pink
#992382	Green



\$22.50 /bag

Ultra Light Refill Full-Face Lenses
Special Buy 4 @ \$20.50/bag
100pcs/bag

Optical-grade lenses for Ultra Light Full-Face Shields. Disposable. Size: 220mm (L) x 170mm (W)

Code	Colour
#992384	Clear
#992385	Orange



\$6.55 each

Safety Eyewear
Special Buy 4 @ \$5.95 each

Made from high grade polycarbonate material with over 99% UV and blue light wavelength (540nm) filtration. Anti-glare, anti-fog and scratch-resistant.

Code	Colour
#992397	Clear
#992396	Yellow
#992398	Black



\$6.05 each

Safety Eyewear
Special Buy 4 @ \$5.50 each

Made from high grade polycarbonate material. Anti-glare, anti-fog and scratch-resistant.

Code	Colour
#992399	Clear



Full-Face Shield

Designed with exclusive 1.5" foam band and ear loops for superior comfort. Anti-fog feature. The shield can be reused once properly disinfected.

Size options:
Standard: 190mm (L)
Extra Long: 230mm (L)

Size	Quantity	Regular Price	Special Price	Code
Standard	24pcs/box	\$29.15/box	Buy 4 @ \$26.50/box	#992372
Extra Long	18pcs/box	\$25.75/box	Buy 4 @ \$23.45/box	#992373

LEVEL 2 FACE MASKS COMPLIANT WITH (AS) 4381:2015

ASTM F2100-14

Bacterial Filtration Efficiency (BFE) ≥ 98%
Differential Pressure < 5.0mm H₂O/cm²
Sub-Micron Particle Filtration Efficiency at 0.1 Micron (PFE) ≥ 98%
Resistance to penetration by synthetic blood / fluids @ 120mmHg
Class 1 Flame Spread

EN 14683:2014

Bacterial Filtration Efficiency (BFE) ≥ 98%
Differential Pressure < 29.4 Pa/cm²
Splash Resistance Pressure - Not Required
Microbial Cleanliness ≤ 30 cfu/g



\$5.55 /box

FREE SAMPLES!

Available in HOT & NEW Promo! (PG 4)



\$8.75 /box

FREE SAMPLES!

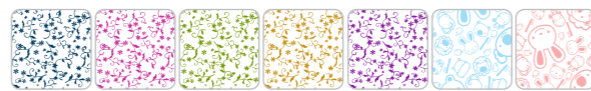

Available in HOT & NEW Promo! (PG 4)

Safe Plus Face Mask

Special Buy 10 @ \$4.95/box

X-Special Buy 20 @ \$4.35/box
50pcs/box

Level 2 single use 3-ply ear loop face mask. Available in various colours. Latex-free, lint-free and fibreglass-free.
Size: 175mm (L) x 90mm (W)



Code	Colour
#992280	Blue
#992281	Pink
#992282	Green
#992284	White
#992285	Purple
#992278	Orange
#992279	Teal

Premium Print Face Mask

Special Buy 10 @ \$7.95/box

X-Special Buy 20 @ \$6.95/box
50pcs/box

Level 2 single use 3-ply ear loop face mask. Latex-free, lint-free and fibreglass-free. Choose from 7 different beautiful prints.
Size: 175mm (L) x 90mm (W)



Code	Colour
#992200	Floral Blue
#992201	Floral Pink
#992202	Floral Green
#992203	Floral Yellow
#992204	Floral Purple
#992205	Blue Zoe
#992206	Pink Zoe

\$15.55 /box

FREE SAMPLES!



Safe Plus Face Mask Visor, Anti-Fog

Special Buy 10 @ \$14.35/box

X-Special Buy 20 @ \$12.55/box
25pcs/box

Level 2 single use 3-ply ear loop face mask with visor and anti-fog barrier strip which prevents visor from fogging up. Latex-free, lint-free and fibreglass-free.
Size: 175mm (L) x 210mm (W)

Code	Colour
#992286	Blue
#992287	Pink

\$5.55 /box

FREE SAMPLES!

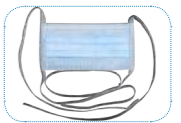

Tie-On Face Mask

Special Buy 4 @ \$5.35/box
50pcs/box

Level 2 single use 3-Ply tie-on face mask. Latex-free, lint-free and fibreglass-free.
Size: 175mm (L) x 90mm (W)

Code	Colour
#992322	Blue

\$6.95 /box

FREE SAMPLES!



Surgical Tie-On Face Mask

Special Buy 4 @ \$6.35/box
50pcs/box

Level 2 single use 3-ply tie-on surgical face mask with extra large panel and extra long ties. Latex-free, lint-free and fibreglass-free.
Size: 175mm (L) x 107mm (W)

Code	Colour
#992325	Blue

LEVEL 3 FACE MASKS COMPLIANT WITH (AS) 4381:2015

ASTM F2100-14

Bacterial Filtration Efficiency (BFE) ≥ 98%
Differential Pressure < 5.0mm H₂O/cm²
Sub-Micron Particle Filtration Efficiency at 0.1 Micron (PFE) ≥ 98%
Resistance to penetration by synthetic blood / fluids @ 160mmHg
Class 1 Flame Spread

EN 14683:2014

Bacterial Filtration Efficiency (BFE) ≥ 98%
Differential Pressure < 49 Pa/cm²
Splash Resistance Pressure ≥ 120mmHg
Microbial Cleanliness ≤ 30 cfu/g



\$8.55 /box

FREE SAMPLES!

Available in HOT & NEW Promo! (PG 4)

Safe Plus NuFIT Face Mask, Anti-Fog

Special Buy 10 @ \$7.95/box

X-Special Buy 20 @ \$6.95/box
40pcs/box

Level 2 single use 3-ply ear loop face mask with enhanced NuFIT protection for a tight, custom fit. Anti-fog, latex-free, lint-free and fibreglass-free.
Size: 175mm (L) x 90mm (W)



Code	Colour
#992288	Blue
#992289	Pink



\$6.95 /box

FREE SAMPLES!

Safe Plus Face Mask, Anti-Fog

Special Buy 10 @ \$6.35/box

X-Special Buy 20 @ \$5.55/box
40pcs/box

Level 2 single use 3-ply ear loop face mask with anti-fog barrier strip which prevents fogging of eyewear. Latex-free, lint-free and fibreglass-free.
Size: 175mm (L) x 90mm (W)



Code	Colour
#992290	Blue
#992291	Pink

\$6.45 /box

FREE SAMPLES!



Ebony Face Mask

Special Buy 10 @ \$5.95/box

X-Special Buy 20 @ \$5.25/box
40pcs/box

Level 3 single use 4-ply ear loop black face mask. Latex-free, lint-free and fibreglass-free.
Size: 175mm (L) x 90mm (W).

Code	Colour
#992263	Black



Available in HOT & NEW Promo! (PG 3)

\$9.45 /box

FREE SAMPLES!



Ebony Face Mask, Anti-Fog

Special Buy 10 @ \$8.75/box

X-Special Buy 20 @ \$7.55/box
40pcs/box

Level 3 single use 4-ply ear loop black face mask with anti-fog barrier strip which prevents fogging of eyewear. Latex-free, lint-free and fibreglass-free.
Size: 175mm (L) x 90mm (W)

Code	Colour
#992264	Black



Available in HOT & NEW Promo! (PG 4)

LEVEL 3 FACE MASKS COMPLIANT WITH (AS) 4381:2015

ASTM F2100-14
Bacterial Filtration Efficiency (BFE) ≥ 98%
Differential Pressure < 5.0mm H2O/cm ²
Sub-Micron Particle Filtration Efficiency at 0.1 Micron (PFE) ≥ 98%
Resistance to penetration by synthetic blood / fluids @ 160mmHg
Class 1 Flame Spread

EN 14683:2014
Bacterial Filtration Efficiency (BFE) ≥ 98%
Differential Pressure < 49 Pa/cm ²
Splash Resistance Pressure ≥ 120mmHg
Microbial Cleanliness ≤ 30 cfu/g



\$5.95 /box

FREE SAMPLES!

HighRISK Face Mask
Special Buy 10 @ \$5.35/box
X-Special Buy 20 @ \$4.85/box
 40pcs/box



Level 3 single use 4-ply ear loop face mask. Latex-free, lint-free, dye-free, chemical-free and fibreglass-free. Size: 175mm (L) x 90mm (W)

Code	Colour
#992340	Blue
#992339	Pink



\$8.95 /box

FREE SAMPLES!

HighRISK Face Mask, Anti-Fog
Special Buy 10 @ \$8.15/box
X-Special Buy 20 @ \$7.35/box
 40pcs/box



Level 3 single use 4-ply ear loop face mask with anti-fog barrier strip which prevents fogging of eyewear. Latex-free, lint-free, dye-free, chemical-free and fibreglass-free. Size: 175mm (L) x 90mm (W)

Code	Colour
#992341	Blue
#992342	Pink



\$8.85 /bag

FREE SAMPLES!

Lab Coat, Knee-Length
Special Buy 4 @ \$8.05/bag
 5pcs/bag

Made from soft, three-layer SMS fabric that is fluid-resistant and breathable. Light yet strong in protection. Three pockets, knitted cuffs and collar with press studs. Latex-Free. Disposable.

S	M	L	XL	Colour
#991455	#991456	#991457	#991458	Blue
#991463	#991464	#991465	#991466	White



\$8.55 /bag

FREE SAMPLES!

Lab Coat, Hip-Length
Special Buy 4 @ \$7.80/bag
 5pcs/bag

Made from soft, three-layer SMS fabric that is fluid-resistant and breathable. Light yet strong in protection. Three pockets, knitted cuffs and collar with press studs. Latex-Free. Disposable.

S	M	L	XL	Colour
#991479	#991480	#991481	#991482	Blue
#991487	#991488	#991489	#991490	White



\$13.50 /bag

FREE SAMPLES!

CPE Apron, Knee-Length
Special Buy 4 @ \$12.25/bag
 50pcs/bag

Disposable clear polyethylene aprons provide excellent protection without limiting movement of flexibility. The aprons do not fully wrap around the user's body to allow for ventilation. Size: 1200mm (L) x 700mm (W)



Code	Colour
#993904	Clear



\$12.80 /bag

FREE SAMPLES!

Isolation Gown, Knee-Length
Special Buy 4 @ \$11.65/bag
 10pcs/bag

An economical, comfortable and reliable protection apparel with knitted cuffs. Seams are sewn together to provide superior strength. Gowns are easily secured with waist and neck ties. Latex-free and fluid-resistant. Size: 1350mm (L) x 1100mm (W)

Code	Colour
#991539	Blue
#991540	Pink
#991541	Green
#991542	White
#991543	Yellow



\$9.55 /box

FREE SAMPLES!

HighRISK NuFIT Face Mask, Anti-Fog
Special Buy 10 @ \$8.75/box
X-Special Buy 20 @ \$7.65/box
 40pcs/box



Level 3 single use 4-ply ear loop face mask with enhanced NuFIT protection for a tight, custom fit. Anti-fog, latex-free, lint-free and fibreglass-free. Latex-free, lint-free, dye-free, chemical-free and fibreglass-free. Size: 175mm (L) x 90mm (W)

Code	Colour
#992346	Blue
#992345	Pink



\$17.55 /box

FREE SAMPLES!

HighRISK NuFIT Face Mask Visor, Anti-Fog
Special Buy 10 @ \$15.75/box
X-Special Buy 20 @ \$14.35/box
 25pcs/box



Level 3 single use 4-ply ear loop face mask with visor and anti-fog barrier strip which prevents visor from fogging up. Enhanced NuFIT protection for a tight, custom fit. Latex-free, lint-free, dye-free, chemical-free and fibreglass-free. Size: 175mm (L) x 210mm (W)

Code	Colour
#992343	Blue
#992344	Pink



MUST BUY!

FREE SAMPLES!

Sterilisation Pouches - Class 2, Self-Sealing

200pcs/box

With internal steam indicator. Triple adhesive seal to protect contents. Blue tinted plastic window helps to detect puncture holes that may be caused by sharp or jagged instruments. Disposable.

Size	Dimensions	Regular Price	Special Price	Code
1	57mm x 130mm (2 1/4" x 4")	\$3.55/box	Buy 2 @ \$3.15/box	#990621
2	50mm x 230mm (2" x 9")	\$4.85/box	Buy 2 @ \$4.35/box	#990614
3	70mm x 230mm (2 3/4" x 9")	\$6.15/box	Buy 2 @ \$5.85/box	#990619
4	90mm x 145mm (3 1/2" x 5 3/4")	\$6.15/box	Buy 2 @ \$5.85/box	#990620
5	90mm x 230mm (3 1/2" x 9")	\$7.35/box	Buy 2 @ \$6.95/box	#990616
6	110mm x 300mm (4 1/4" x 11")	\$12.05/box	Buy 2 @ \$10.95/box	#990613
7	135mm x 260mm (5 1/4" x 10")	\$12.75/box	Buy 2 @ \$11.55/box	#990617
8	190mm x 330mm (7 1/2" x 13")	\$20.65/box	Buy 2 @ \$18.75/box	#990618
9	250mm x 380mm (10" x 15")	\$41.95/box	Buy 2 @ \$39.95/box	#990611
10	300mm x 380mm (12" x 15")	\$63.75/box	Buy 2 @ \$57.95/box	#990612
11	300mm x 460mm (12" x 18")	\$74.75/box	Buy 2 @ \$67.95/box	#990615



Autoclavable Indicator Tape

55 metres/roll

For steam sterilisation only. Autoclavable Indicator Tape can be used in 121°C gravity and 132°C - 134°C vacuum-assisted sterilisation cycles. Printed diagonal stripes darken to indicate that instruments or items have gone through the sterilization process.



Before Sterilisation



After Sterilisation

Size	Dimensions	Regular Price	Special Price	Code
1	13mm x 55 metres	\$3.85/roll	Buy 4 @ \$3.65/roll	#990670
2	19mm x 55 metres	\$4.85/roll	Buy 4 @ \$4.55/roll	#990671
3	25mm x 55 metres	\$6.25/roll	Buy 4 @ \$5.95/roll	#990672

CSR Sterilisation Wrap

Conforms easily to various instruments and items of various shapes and sizes. Designed for use with ETO, steam and gamma irradiation and sterilisation. These wraps provide an effective bacterial barrier to both airborne and waterborne contamination.



FREE SAMPLES!

Size	Dimensions	Regular Price	Special Price	Code
1	300mm x 300mm (100pcs/bag)	\$6.85/bag	Buy 4 @ \$6.15/bag	#990655
2	380mm x 380mm (100pcs/bag)	\$11.95/bag	Buy 4 @ \$10.75/bag	#990656
3	500mm x 500mm (100pcs/bag)	\$21.65/bag	Buy 4 @ \$19.95/bag	#990657
4	610mm x 610mm (100pcs/bag)	\$29.65/bag	Buy 4 @ \$26.95/bag	#990658
5	760mm x 760mm (50pcs/bag)	\$24.25/bag	Buy 4 @ \$21.95/bag	#990659



MUST BUY!

Sterilisation Roll - Class 2 (Steam Sterilisation Only)

200 metres/roll

With internal steam indicator. Triple adhesive seal to protect contents. Blue tinted plastic window helps to detect puncture holes that may be caused by sharp or jagged instruments. Disposable.

Size	Dimensions	Regular Price	Special Price	Code
1	50mm x 200metres	\$17.95/roll	Buy 2 @16.35/roll	#990632
2	75mm x 200metres	\$21.95/roll	Buy 2 @19.95/roll	#990633
3	100mm x 200metres	\$28.95/roll	Buy 2 @26.35/roll	#990634
4	150mm x 200metres	\$39.95/roll	Buy 2 @38.35/roll	#990635
5	200mm x 200metres	\$65.95/roll	Buy 2 @62.95/roll	#990636
6	250mm x 200metres	\$82.95/roll	Buy 2 @80.95/roll	#990637
7	300mm x 200metres	\$93.95/roll	Buy 2 @89.95/roll	#990638



Sterile Surgical Drape - EO Gas Sterilised

20pcs/box

Made of polypropylene with lamination. Ideal for dental implant surgeries to reduce bacterial transfer and contamination of the surgical site. These drapes are highly absorbent. Clean-up time is greatly reduced.

Size	Dimensions	Regular Price	Special Price	Code
1	450mm x 750mm	\$13.95/box	Buy 4 @ \$12.95/box	#990720
2	600mm x 600mm	\$13.95/box	Buy 4 @ \$12.95/box	#990721
3	900mm x 900mm	\$19.95/box	Buy 4 @ \$18.95/box	#990722



Sterile Surgical Drape with Hole - EO Gas Sterilised

10pcs/box

Made of polypropylene with lamination. Ideal for dental implant surgeries to protect patients from dental polish, fluids and blood during the surgical procedure. The triangular opening is designed for easy positioning and placement over the patient's face and mouth.

Size	Dimensions	Regular Price	Special Price	Code
2	600mm x 800mm	\$13.95/box	Buy 4 @ \$12.95/box	#990710
3	900mm x 1200mm	\$19.95/box	Buy 4 @ \$18.95/bag	#990711

Each strip can be cut to make two pieces.

\$3.25 /box

Indicator Strips
Special Buy 4 @ \$2.95/box
 100pcs/box

For steam sterilisation only. Disposable.
 Size: 90mm (L) x 20mm (W)

FREE SAMPLES!

Code #990650



\$4.10 /bag

FREE SAMPLES!

Air/Water Syringe Tips
Special Buy 4 @ \$3.70/bag
 50pcs/bag

Tips have an inner core water chamber that seats into the syringe, eliminating water contamination in the air chamber. Quad core design ensures instant dry air, prevents cross-contamination and delivers superior air/water spray. Disposable.

Code	Colour
#990906	Clear/Blue
#990907	Clear/White
#990908	Clear/Clear
#990910	Assorted

MUST BUY!



Intraoral Camera Sleeves
Special Buy 4 @ \$9.00/box
 100pcs/box

Prevents cross-contamination, composite and bacteria build-up on curing light tips. Reduces the need to use harmful disinfectants.

\$9.95 /box

FREE SAMPLES!

Colour/TIDI Code	Intraoral Camera Machine	Intraoral Camera Machine	Sleeves Size	Product Code
Clear/20810	DMD	Telicam	228mm (L) x 43mm (W) x 13.5mm (Diameter)	#992585
Clear/20855	Siemens	Ceracam/Minicam Ultra	228mm (L) x 43mm (W) x 24mm (Diameter)	#992586
Clear/20856	Dentsply	Acucap Concept	228mm (L) x 43mm (W) x 16.6mm (Diameter)	#992587
Clear/20917	Camsight	Optum II	228mm (L) x 25mm (W) x 17mm (Diameter)	#992588
Clear/20964	RF System	SS21	228mm (L) x 57mm (W) x 22mm (Diameter)	#992589
Clear/20969	Suni	Sunic-am	228mm (L) x 31mm (W) x 48mm (Diameter)	#992590
Clear/21013	Digital Doc	Iris	228mm (L) x 41mm (W) x 10mm (Diameter)	#992591
Clear/20805	Vision Tools	Spectra Vu	228mm (L) x 57mm (W) x 12mm (Diameter)	#992592
Clear/20987	Imagin	Hot Rod	228mm (L) x 50mm (W) x 17.5mm (Diameter)	#992593
Clear/20829	Carestream	STV Pro I & II Kodak 1000	228mm (L) x 35mm (W) x 18mm (Diameter)	#992594
Clear/20909	Video Dental Concepts	Miniscope & Microscope TD-2000	228mm (L) x 53mm (W) x 29mm (Diameter)	#992595
Clear/20911	Digital Doc	Aurora	228mm (L) x 35mm (W) x 22mm (Diameter)	#992596



\$4.00 /bag

FREE SAMPLES!

Disposable Wash Cloth
Special Buy 4 @ \$3.60/bag
 50pcs/bag

Highly absorbent and durable wash cloth for heavy-duty clean-ups. Disposable.
 Size: 310mm (L) x 320mm (W)

Code	Colour
#991909	White

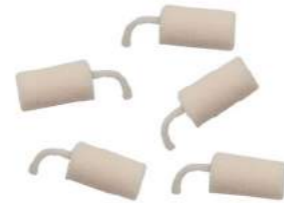

\$26.65 /bag

FREE SAMPLES!

Mirror Wipes
Special Buy 4 @ \$24.25/bag
 200pcs/bag

Remove moisture and debris from the mouth mirror easily and quickly. With these handy mirror wipes, dental professionals do not need to remove the mirror from the patient's mouth. These mirror wipes can be affixed easily onto syringe tips.



Code
#990909



\$6.55 /roll

FREE SAMPLES!

Cleaning Wipes - Coreless
Special Buy 4 @ \$5.95/roll
 90pcs/roll

Made from spunlace non-woven fabric that is water-absorbent. Removes dust, liquid spills and contaminants. Ideal for cleaning instruments and hands. Each wipe measures 370mm (L) x 200mm (W).

Code
#991912



\$9.85 each

Cleaning Wipes Dispenser
Special Buy 4 @ \$8.95 each

Ideal for storing and dispensing cleaning wipes.

Code	Colour
#991916	White

INSTRUMENTS & ACCESSORIES

INSTRUMENTS & ACCESSORIES

INSTRUMENTS & ACCESSORIES

INSTRUMENTS & ACCESSORIES



\$9.20 each

Amalgam Carrier - Straight
Special Buy 4 @ \$8.35 each

Ideal for carrying dental amalgam, a combination of liquid mercury and metal alloy mixture for filling tooth cavities. It has a push handle, angled deliver socket and spring bolt. Autoclavable up to 135°. Reusable. Non-sterile.

Code	Colour
#990881	Blue
#990884	White



\$9.20 each

Amalgam Carrier - Mini Right Angle
Special Buy 4 @ \$8.35 each

Ideal for carrying dental amalgam, a combination of liquid mercury and metal alloy mixture for filling tooth cavities. It has a push handle, angled deliver socket and spring bolt. Autoclavable up to 135°. Reusable. Non-sterile.

Code	Colour
#990882	Blue
#990885	White



\$9.20 each

Amalgam Carrier - Right Angle
Special Buy 4 @ \$8.35 each

Ideal for carrying dental amalgam, a combination of liquid mercury and metal alloy mixture for filling tooth cavities. It has a push handle, angled deliver socket and spring bolt. Autoclavable up to 135°. Reusable. Non-sterile.

Code	Colour
#990883	Blue
#990886	White



\$8.90 each

Stainless Steel Mesh
Special Buy 4 @ \$8.10 each

Designed to clean burs, files and small instruments. Autoclavable up to 135°.

Code	Colour
#993268	Silver



\$91.90 each

LED Light Mirror
Special Buy 4 @ \$83.50 each

Designed for clearer examination of the oral cavity. 2 AA batteries included. Mirror is removable and autoclavable up to 135°.

Code	Colour
#993231	Silver



\$355.50 /set

LED Light Mirror Set
Special Buy 4 @ \$323.50/set

Long life of 20,000 hours. Long handle to avoid infection with anti-slip silicon grip. Each set comes with 1 LED lamp, 10 mirrors and 5 AA batteries. Mirror is removable and autoclavable up to 135°.

Code	Colour
#993230	Silver

2, 4, 6, 8

\$20.75 /bag

Periodontal Probe and Explorer
Special Buy 4 @ \$18.85/bag
10pcs/bag

This periodontal resin probe has a scale of 2mm, 4mm, 6mm and 8mm on one end. The resin probe is bendable and flexible. On another end of the probe is a #6 stainless steel explorer. Autoclavable up to 135°.

Code	Colour
#993269	Cream

3, 6, 9, 12

\$20.75 /bag

Periodontal Probe and Explorer
Special Buy 4 @ \$18.85/bag
10pcs/bag

This periodontal resin probe has a scale of 3mm, 6mm, 9mm and 12mm on one end. The resin probe is bendable and flexible. On another end of the probe is a #6 stainless steel explorer. Autoclavable up to 135°.

Code	Colour
#993270	Cream



\$20.20 /box

Autoclavable Mouth Mirrors
Special Buy 4 @ \$18.35/box
20pcs/box

Double-sided mouth mirror with clear visibility. Autoclavable up to 135°. Size: 175mm (L)

Code	Colour
#993233	Blue
#993234	Pink
#993235	Green
#993236	Yellow
#993237	Purple



\$28.55 each

Tongue Retractor
Special Buy 4 @ \$25.95 each

Designed to hold patient's tongue away from the surgical area. Autoclavable up to 135°. Size: 190mm (L)

Code	Colour
#993265	Grey



\$23.00 /box

Sterile Instrument Kit, 2pcs
Special Buy 4 @ \$21.00/box
50 kits/box

ETO gas sterilised instrument kit containing 1 probe and 1 mirror per kit.

Code
#990730



\$38.35 /box

Sterile Instrument Kit, 3pcs
Special Buy 4 @ \$34.85/box
50 kits/box

ETO gas sterilised instrument kit containing 1 probe, 1 mirror and 1 tweezer per kit.

Code
#990731

NuMedical

NuMedical



\$6.70 /box

Plastic Wedges, 10mm

Special Buy 4 @ \$6.10/box
100pcs/box

Ideal for intraoral dental procedures. These are used to slightly separate the patient's teeth during the placement of a filling material, or to stabilize and support other devices, ie: a matrix band or a rubber dam. Single-use.

Code	Colour
#993100	Blue



\$6.70 /box

Plastic Wedges, 12mm

Special Buy 4 @ \$6.10/box
100pcs/box

Ideal for intraoral dental procedures. These are used to slightly separate the patient's teeth during the placement of a filling material, or to stabilize and support other devices, ie: a matrix band or a rubber dam. Single-use.

Code	Colour
#993101	Green



\$2.15 /bag

Inlay Crown Bridge Setter

Special Buy 4 @ \$1.95 each

Designed for precise inlay setting of crowns and bridges with anti-slip handle. Autoclavable up to 135°C. Size: 142mm (L)

Code	Colour
#993105	Green



\$46.75 /box

Metal Inlay Setter

Special Buy 4 @ \$42.50/box
2pcs/box

Designed for precise inlay setting of crowns and bridges. Each box comes with 2 metal handles and 4 silicone pads. Autoclavable up to 135°C. Size: 80mm (L) x 22mm (W)

Code
#993104



\$6.70 /box

Plastic Wedges, 14mm

Special Buy 4 @ \$6.10/box
100pcs/box

Ideal for intraoral dental procedures. These are used to slightly separate the patient's teeth during the placement of a filling material, or to stabilize and support other devices, ie: a matrix band or a rubber dam. Single-use.

Code	Colour
#993102	Yellow



\$6.70 /box

Plastic Wedges, 16mm

Special Buy 4 @ \$6.10/box
100pcs/box

Ideal for intraoral dental procedures. These are used to slightly separate the patient's teeth during the placement of a filling material, or to stabilize and support other devices, ie: a matrix band or a rubber dam. Single-use.

Code	Colour
#993103	Purple



\$59.00 /set

Cervical Former Kit

Special Buy 4 @ \$53.65/set

The kit includes a long, bent holder that is made of stainless steel and 50 pieces of cervical matrices, also available in the form of refills. The holder is autoclavable up to 135°C. The cervical matrices are made of transparent polyester, providing flexibility, rigidity, and adaptability. Ideal for Class 5 fillings and provides smooth-surfaced and non-porous restoration with minimal finishing and polishing work.

Code
#993128



\$10.50 /bag

Matrices Refill

Special Buy 4 @ \$9.50/bag
50pcs/bag

Made of transparent polyester, providing flexibility, rigidity, and adaptability. Disposable.

Code	Colour
#993129	Clear



\$10.95 /box

Fleximeter Strips

Special Buy 4 @ \$9.95/box
4pcs/box

Made from a special silicone material, these strips are flexible measuring instruments in four different thickness sizes; 0.5mm, 1.0mm, 1.5mm and 2.0mm. They are used to measure the height of the preparation on grinding teeth for restoration such as crowns and bridges. They can also be used to enlarge the vertical dimension (height of bite). Autoclavable up to 135°C.

Code	Colour
#993130	Green



\$1.05 /bag

Matrix Bands

Special Buy 4 @ \$0.95/bag
10pcs/bag

Made from the highest quality medical grade stainless steel. Autoclavable up to 135°C.

Size	Code	Colour
#1 (0.04mm)	#993108	Stainless Steel
#2 (0.04mm)	#993106	Stainless Steel
#3 (0.04mm)	#993110	Stainless Steel
#13 (0.04mm)	#993112	Stainless Steel





Super Elastic NiTi Archwires - Round

Special Buy 4 @ \$4.05/pack
10pcs/pack

\$4.45 /pack

Made from Nickel Titanium, super-elastic.



Size	UPPER			LOWER		
	Square	Ovoid	Nature	Square	Ovoid	Nature
0.012"	#995942	#995952	#995962	#995947	#995957	#995967
0.014"	#995943	#995953	#995963	#995948	#995958	#995968
0.016"	#995944	#995954	#995964	#995949	#995959	#995969
0.018"	#995945	#995955	#995965	#995950	#995960	#995970
0.020"	#995946	#995956	#995966	#995951	#995961	#995971



Heat Activated NiTi Archwires - Round

Special Buy 4 @ \$3.55/pack
5pcs/pack

\$3.95 /pack

Made from Nickel Titanium, heat-activated.



Size	UPPER			LOWER		
	Square	Ovoid	Nature	Square	Ovoid	Nature
0.012"	#996020	#996030	#996040	#996025	#996035	#996045
0.014"	#996021	#996031	#996041	#996026	#996036	#996046
0.016"	#996022	#996032	#996042	#996027	#996037	#996047
0.018"	#996023	#996033	#996043	#996028	#996038	#996048
0.020"	#996024	#996034	#996044	#996029	#996039	#996049



Super Elastic NiTi Archwires - Rectangular

Special Buy 4 @ \$6.85/pack
10pcs/pack

\$7.55 /pack

Made from Nickel Titanium, super-elastic.



Size	UPPER			LOWER		
	Square	Ovoid	Nature	Square	Ovoid	Nature
0.016" x 0.016"	#995972	#995988	#996004	#995980	#995996	#996012
0.016" x 0.022"	#995973	#995989	#996005	#995981	#995997	#996013
0.017" x 0.022"	#995974	#995990	#996006	#995982	#995998	#996014
0.017" x 0.025"	#995975	#995991	#996007	#995983	#995999	#996015
0.018" x 0.022"	#995976	#995992	#996008	#995984	#996000	#996016
0.018" x 0.025"	#995977	#995993	#996009	#995985	#996001	#996017
0.019" x 0.025"	#995978	#995994	#996010	#995986	#996002	#996018
0.021" x 0.025"	#995979	#995995	#996011	#995987	#996003	#996019



Heat Activated NiTi Archwires - Rectangular

Special Buy 4 @ \$5.35/pack
5pcs/pack

\$5.95 /pack

Made from Nickel Titanium, heat-activated.



Size	UPPER			LOWER		
	Square	Ovoid	Nature	Square	Ovoid	Nature
0.016" x 0.016"	#996050	#996066	#996082	#996058	#996074	#996090
0.016" x 0.022"	#996051	#996067	#996083	#996059	#996075	#996091
0.017" x 0.022"	#996052	#996068	#996084	#996060	#996076	#996092
0.017" x 0.025"	#996053	#996069	#996085	#996061	#996077	#996093
0.018" x 0.022"	#996054	#996070	#996086	#996062	#996078	#996094
0.018" x 0.025"	#996055	#996071	#996087	#996063	#996079	#996095
0.019" x 0.025"	#996056	#996072	#996088	#996064	#996080	#996096
0.021" x 0.025"	#996057	#996073	#996089	#996065	#996081	#996097

Orthodontic Pliers

Special Buy 4 @ \$124.35 each

\$136.75 each

Orthodontic Pliers

Special Buy 4 @ \$124.35 each

\$136.75 each

Code #995909

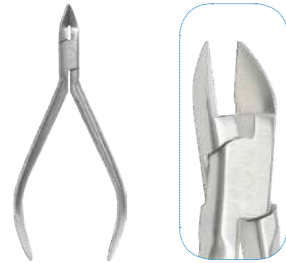

Light Wire Cutter 0° Standard

Hardness: HRC 60-65. Designed to cut ligature wires or elastic rings up to 0.021" (0.30 mm). Can't be used for cutting archwires.

Code #995910



Light Wire Cutter 0° Long Handle

Hardness: HRC 60-65. Designed to cut ligature wires or elastic rings up to 0.021" (0.30 mm). Can't be used for cutting archwires.

Code #995911



Distal End Cutter Standard

Hardness: HRC 60-65. Designed to cut the long distal end of wires up to 0.021" x 0.025" (0.53 mm x 0.64 mm). It securely holds the cut part.

Code #995918



Light Wire Plier Long Handle

Hardness: HRC 60-65. Designed to bend archwires to make fine loops or spring loops.

Code #995919



Light Wire Plier with Cutter Standard

Hardness: HRC 60-65. Designed to bend archwires to make fine loops or spring loops. The middle part of the jaw is used for cutting.

Code #995920



Light Wire Plier with Cutter Long Handle

Hardness: HRC 60-65. Designed to bend archwires to make fine loops or spring loops. The middle part of the jaw is used for cutting.

Code #995912



Distal End Cutter Long Handle

Hardness: HRC 60-65. Designed to cut the long distal end of wires up to 0.021" x 0.025" (0.53 mm x 0.64 mm). It securely holds the cut part.

Code #995913



Distal End Cutter Flush Standard

Hardness: HRC 60-65. Cuts and holds wire distally flush to the buccal tube or bracket while reducing debondings. Wires up to 0.021" x 0.025" (0.53 mm x 0.64 mm).

Code #995914



Distal End Cutter Flush Long Handle

Hardness: HRC 60-65. Cuts and holds wire distally flush to the buccal tube or bracket while reducing debondings. Wires up to 0.021" x 0.025" (0.53 mm x 0.64 mm).

Code #995921



Heavy Wire Cutter Standard

Hardness: HRC 60-65. Designed to cut various Australian wires, NiTi wires and stainless steel wires up to maximum diameter of 0.030" (0.76mm).

Code #995922



Heavy Wire Cutter Long Handle

Hardness: HRC 60-65. Designed to cut various Australian wires, NiTi wires and stainless steel wires up to maximum diameter of 0.030" (0.76mm).

Code #995923



V Stop Plier

Hardness: HRC 60-65. Designed to make V stop along archwires to prevent any movement.

Code #995915



NiTi Cinch Back Plier Standard

Hardness: HRC 60-65. Designed to cinch back distal end of archwires to avoid causing injury to soft tissue. For archwires up to maximum diameter of 0.021" (0.53 mm).

Code #995916



NiTi Cinch Back Plier Long Handle

Hardness: HRC 60-65. Designed to cinch back distal end of archwires to avoid causing injury to soft tissue. For archwires up to maximum diameter of 0.021" (0.53 mm).

Code #995917



Light Wire Plier Standard

Hardness: HRC 60-65. Designed to bend archwires to make fine loops or spring loops.

Code #995924



Multi Function Plier

Hardness: HRC 52-55. Designed to bend, flatten and cut wires.

Code #995925



Torque Plier

Hardness: HRC 60-65. Designed to be used in pair to make torques on rectangle wires, thickness of tips: 0.050" (1.27mm).

Code #995926



Tweed Loop Plier

Hardness: HRC 60-65. Designed to make small loops, distal stops and Q loops on archwires up to 0.022" (0.56mm).

Orthodontic Pliers

Special Buy 4 @ \$124.35 each

\$136.75 each

Code #995927



Band Remover

Hardness: HRC 52-55. Designed to remove bands and other bondable attachments in the posterior section.

Code #995928



Anterior Bracket Removing Plier

Hardness: HRC 52-55. Designed to remove anterior brackets.

Code #995929



Posterior Bracket Removing Plier Standard

Hardness: HRC 52-55. Designed to remove posterior brackets.

Orthodontic Pliers

Special Buy 4 @ \$124.35 each

\$136.75 each

Code #995936

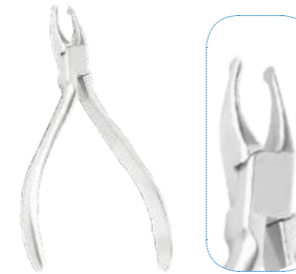

How Plier

Hardness: HRC 52-55. Designed to hold archwires when guiding into buccal tubes, to hold ligature wires, or to form anterior band.

Code #995937

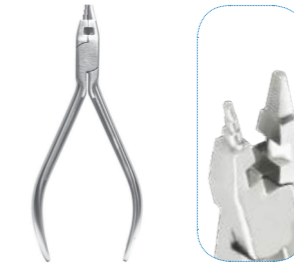

Kim Plier

Hardness: HRC 52-55. Designed to bend multi-loop edgewise wires, with cutter on tips.

Code #995938



Nance Loop Bending Plier

Hardness: HRC 52-55. Designed to make vertical loops of different height along archwires, 3.0, 4.0, 5.0, 6.0mm. Wires' diameter up to: 0.022" (0.56mm).

Code #995930



Posterior Bracket Removing Plier Long Handle

Hardness: HRC 52-55. Designed to remove posterior brackets.

Code #995931



Weingart Plier Standard

Hardness: HRC 52-55. Designed to cinch back distal end of archwires to prevent injury to soft tissue. NiTi wires' diameter up to 0.021" (0.53mm).

Code #995932



Weingart Plier Long Handle

Hardness: HRC 52-55. Designed to cinch back distal end of archwires to prevent injury to soft tissue. NiTi wires' diameter up to 0.021" (0.53mm).

Code #995939



Bond Remover

Hardness: HRC 52-55. Designed to remove bond on the crown without any injury on enamel.

Code #995940



Three Jaw Plier

Hardness: HRC 52-55. Designed to make V loops and bend archwires. Wires' diameter up to 0.030" (0.76mm).

Code #995941



Omega Loop Bending Plier

Hardness: HRC 52-55. Designed to make fine Ω loops. Loops diameters: 0.063", 0.075", 0.10" (1.6mm, 2.0mm, 2.6mm).

Code #995933

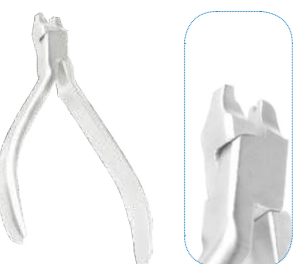

Crimpable Hook Plier Standard

Hardness: HRC 52-55. Designed to fix the crimpable hooks along archwires.

Code #995934

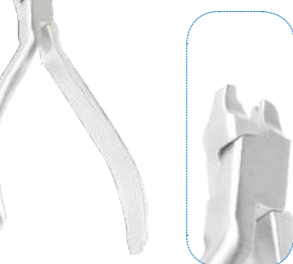

Crimpable Hook Plier Long Handle

Hardness: HRC 52-55. Designed to fix the crimpable hooks along archwires.

Code #995935



Loop Bending Plier

Hardness: HRC 52-55. Designed to make different small loops for multi-loop edgewise archwires. Loop diameters: 2mm, 3.2mm and 4.2mm.

Code #996146

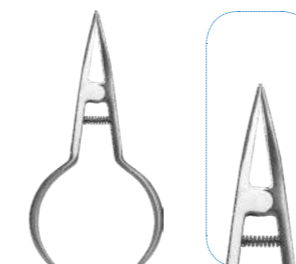

Elastic Plier

Hardness: HRC 52-55. Designed to expand elastic separating rings before separating molar gap.

ORTHODONTICS

ORTHODONTICS

NuMedical

NuMedical



Mini Ceramic Brackets

Special Buy 4 @ \$45.45/set
20pcs/set

\$49.95 /set

- Pure Polycrystalline aesthetic ceramic
- Twin wing
- Contoured design with rounded edge for maximum patient comfort
- Optimal base for superior bonding/debonding
- Low profile height design

ROTH TYPE

Size	With Hook 3	With Hook 3, 4, 5
18	#993362	#993363
22	#993360	#993361

MBT TYPE

Size	With Hook 3	With Hook 3, 4, 5
18	#993366	#993367
22	#993364	#993365



Mini Metal Brackets (Laser-Welded)

Special Buy 4 @ \$16.35/set
20pcs/set

\$17.95 /set

- Rounded edge for maximum patient comfort
- Low profile height design
- Optimal base for superior bonding/debonding
- Laser-welding technology

ROTH TYPE

Size	With Hook 3	With Hook 3, 4, 5
18	#994392	#994393
22	#994390	#994391



Mini Metal Self-Ligating Brackets

Special Buy 4 @ \$132.65/set
20pcs/set

\$145.95 /set

- Rounded edge for maximum patient comfort
- Low profile height design
- Optimal base for superior bonding/debonding
- Self-ligating clip
- MIM advanced technology

Buy now and get
**ONE SL Tool
FOR FREE**



ROTH TYPE

Size	With Hook 3	With Hook 3, 4, 5
18	#994388	#994389
22	#994386	#994387



Ultra Clear Mini Ceramic Brackets

Special Buy 4 @ \$171.35/set
20pcs/set

\$188.65 /set

- True twin wings and low profile design for excellent performance
- World's first 2-Step groove for easy and accurate positioning
- Rounded edge and full-body coating
- Plasma-silica coating for superior sliding and to minimise fracture risks
- Half base coating for superior retention and easy debonding
- Low profile height design

ROTH TYPE

Size	With Hook 3	With Hook 3, 4, 5
18	#993454	#993455
22	#993452	#993453

MBT TYPE

Size	With Hook 3	With Hook 3, 4, 5
18	#993458	#993459
22	#993456	#993457



Mini Ceramic Self-Ligating Brackets

Special Buy 4 @ \$328.95/set
20pcs/set

\$361.95 /set

- Rounded edge for maximum patient comfort
- Tooth-coloured clips with Rhodium coating
- Optimal base for superior bonding/debonding
- Low profile height design

ROTH TYPE

Size	With Hook 3, 4, 5
22	#994395

Standard Metal Brackets (80 Mesh Base)

Special Buy 4 @ \$14.95/set

20pcs/set

- Rounded edge for maximum patient comfort
- Low profile height design
- Optimal base for superior bonding/debonding
- Low profile height design

\$16.45 /set



ROTH TYPE

Size	Without Hook	With Hook 3	With Hook 3, 4, 5
18	#994422	#994423	#994424
22	#994419	#994420	#994421

MBT TYPE

Size	Without Hook	With Hook 3	With Hook 3, 4, 5
18	#994428	#994429	#994430
22	#994425	#994426	#994427

Mini Metal Brackets (80 Mesh Base)

Special Buy 4 @ \$14.95/set

20pcs/set

- Rounded edge for maximum patient comfort
- Low profile height design
- Optimal base for superior bonding/debonding
- Low profile height design

\$16.45 /set



ROTH TYPE

Size	Without Hook	With Hook 3	With Hook 3, 4, 5
18	#994434	#994435	#994436
22	#994431	#994432	#994433

MBT TYPE

Size	Without Hook	With Hook 3	With Hook 3, 4, 5
18	#994440	#994441	#994442
22	#994437	#994438	#994439



Buccal Tubes Trumpeted Opening (Non-Convertible)

Special Buy 4 @ \$1.45 each

- Low profile design enhances bonding strength
- Smooth-surface hooks for maximum patient comfort
- Funneled entrance guides wire into the buccal tube

\$1.65 each

MAXILLIARY SINGLE BONDABLE (RECTANGULAR TUBE)

	Torque	Distal Offset	Length	Designation	ROTH TYPE		MBT TYPE	
					0.018"	0.022"	0.018"	0.022"
1st Molar	(-) 14°	10°	4	Upper Right	#995830	#995834	#995832	#995836
	(-) 14°	10°	4	Upper Left	#995831	#995835	#995833	#995837
2nd Molar	(-) 14°	10°	4	Upper Right	#995846	#995850	#995848	#995852
	(-) 14°	10°	4	Upper Left	#995847	#995851	#995849	#995853

MANDIBULAR SINGLE BONDABLE (RECTANGULAR TUBE)

	Torque	Distal Offset	Length	Designation	ROTH TYPE	
					0.018"	0.022"
1st Molar	(-) 25°	4°	4	Lower Right	#995838	#995842
	(-) 25°	4°	4	Lower Left	#995839	#995843
2nd Molar	(-) 25°	4°	4	Lower Right	#995854	#996157
	(-) 25°	4°	4	Lower Left	#995855	#996158

MANDIBULAR SINGLE BONDABLE (RECTANGULAR TUBE)

	Torque	Distal Offset	Length	Designation	MBT TYPE	
					0.018"	0.022"
1st Molar	(-) 20°	0°	4	Lower Right	#995840	#995844
	(-) 20°	0°	4	Lower Left	#995841	#995845
2nd Molar	(-) 20°	0°	4	Lower Right	#995856	#996159
	(-) 20°	0°	4	Lower Left	#996156	#996160



Buccal Tubes (Non-Convertible)

Special Buy 4 @ \$1.45 each

- Low profile design reduces occlusal interference
- * Comfortable hooks for maximum patient comfort
- Anatomically conforms to teeth

\$1.65 each



Buccal Tubes (Convertible)

Special Buy 4 @ \$1.45 each

- Low profile design reduces occlusal interference
- * Comfortable hooks for maximum patient comfort
- Anatomically conforms to teeth

\$1.65 each

MAXILLIARY SINGLE BONDABLE (RECTANGULAR TUBE)					ROTH TYPE		MBT TYPE	
	Torque	Distal Offset	Length	Designation	0.018"	0.022"	0.018"	0.022"
1st Molar	(-) 14°	10°	4	Upper Right	#996161	#996165	#996163	#996167
	(-) 14°	10°	4	Upper Left	#996162	#996166	#996164	#996168
2nd Molar	(-) 14°	10°	4	Upper Right	#996177	#996181	#996179	#996183
	(-) 14°	10°	4	Upper Left	#996178	#996182	#996180	#996184

MAXILLIARY SINGLE BONDABLE (RECTANGULAR TUBE)					ROTH TYPE		MBT TYPE	
	Torque	Distal Offset	Length	Designation	0.018"	0.022"	0.018"	0.022"
1st Molar	(-) 14°	10°	4	Upper Right	#996193	#996197	#996195	#996199
	(-) 14°	10°	4	Upper Left	#996194	#996198	#996196	#996200

MANDIBULAR SINGLE BONDABLE (RECTANGULAR TUBE)					ROTH TYPE	
	Torque	Distal Offset	Length	Designation	0.018"	0.022"
1st Molar	(-) 25°	4°	4	Lower Right	#996169	#996173
	(-) 25°	4°	4	Lower Left	#996170	#996174
2nd Molar	(-) 25°	4°	4	Lower Right	#996185	#996189
	(-) 25°	4°	4	Lower Left	#996186	#996190

MANDIBULAR SINGLE BONDABLE (RECTANGULAR TUBE)					ROTH TYPE	
	Torque	Distal Offset	Length	Designation	0.018"	0.022"
1st Molar	(-) 25°	4°	4	Lower Right	#996201	#996205
	(-) 25°	4°	4	Lower Left	#996202	#996206

MANDIBULAR SINGLE BONDABLE (RECTANGULAR TUBE)					MBT TYPE	
	Torque	Distal Offset	Length	Designation	0.018"	0.022"
1st Molar	(-) 20°	0°	4	Lower Right	#996171	#996175
	(-) 20°	0°	4	Lower Left	#996172	#996176
2nd Molar	(-) 20°	0°	4	Lower Right	#996187	#996191
	(-) 20°	0°	4	Lower Left	#996188	#996192

MANDIBULAR SINGLE BONDABLE (RECTANGULAR TUBE)					MBT TYPE	
	Torque	Distal Offset	Length	Designation	0.018"	0.022"
1st Molar	(-) 20°	0°	4	Lower Right	#996203	#996207
	(-) 20°	0°	4	Lower Left	#996204	#996208



Molar Bands

Special Buy 4 @ \$3.15/pack
4 pcs/pack

\$3.45 /pack



- Permanent laser ID marking
- Straight interproximal walls for reduced separation
- Reduced gingival/occlusal dimensions for less occlusal and gingival interferences
- Available with micro-etched inner surface for increased retention
- Curved festooned occlusal interproximal walls
- Increased occlusal "Edge" strength for reduced deformation

1ST MOLAR BANDS														
SIZE														
34	34+	35	35+	36	36+	37	37+	38	38+	39	39+	40	40+	41
PERIMETER (MM)														
34	34.5	35	35.5	36	36.5	37	37.5	38	38.5	39	39.5	40	40.5	41
#994443	#994444	#994445	#994446	#994447	#994448	#994449	#994450	#994451	#994452	#994453	#994454	#994455	#994456	#994457

2ND MOLAR BANDS														
SIZE														
31	31+	32	32+	33	33+	34	34+	35	35+	36	36+	37	37+	38
PERIMETER (MM)														
31	31.5	32	32.5	33	33.5	34	34.5	35	35.5	36	36.5	37	37.5	38
#994458	#994459	#994460	#994461	#994462	#994463	#994464	#994465	#994466	#994467	#994468	#994469	#994470	#994471	#994472

Accessories



Ball Top



T Top



Long Curved

Crimpable Hooks

10 pcs/pack

Made from high quality stainless steel. Easily place onto any archwire inside or outside the mouth. Secure anchor for any auxiliary attachment with bi-directional hook for easy ligation. Fits archwires from 0.022" (0.56mm) to 0.025" (0.64mm).

Width	Regular Price	Special Price	T Top	Ball Top	Long Curved
2.1mm	\$5.45/pack	Buy 4 @ \$5.05/pack	#995857	#995862	
2.7mm	\$5.45/pack	Buy 4 @ \$5.05/pack	#995858	#995863	
4.0mm	\$5.45/pack	Buy 4 @ \$5.05/pack	#995859	#995864	
5.5mm	\$5.45/pack	Buy 4 @ \$5.05/pack	#995860	#995865	
7.0mm	\$5.45/pack	Buy 4 @ \$5.05/pack	#995861	#995866	
7.0mm (Universal left)	\$12.85/pack	Buy 4 @ \$11.65/pack			#995867
7.0mm (Universal right)	\$12.85/pack	Buy 4 @ \$11.65/pack			#995868



\$5.45 /pack

Crimpable Stops

Special Buy 4 @ \$5.05/pack
10 pcs/pack

Crimpable stops can easily be placed anywhere on the archwire at a desired point. Will firmly remain in place during treatment
Width: Universal.

Code
#995869



\$8.75 /pack

NiTi Open Springs

Special Buy 4 @ \$7.96/pack
2 pcs/pack

Nickel-titanium open coil springs deliver continuous force over extended ranges to open spaces to accommodate new teeth.

	0.010"	0.020"
180mm	#995880	#995881



\$4.95 /pack

NiTi Close Springs

Special Buy 4 @ \$4.55/pack
10 pcs/pack

Nickel-titanium closed coil springs deliver continuous force over extended ranges of activation and working times to assist maintaining space between two teeth.

Force	9mm	10mm	12mm	14mm	16mm
Light (0.008)	#995870	#995871	#995872	#995873	#995874
Medium (0.01)	#995875	#995876	#995877	#995878	#995879



\$4.45 /roll

Ligature Wire - Round

Special Buy 4 @ \$4.05/roll
50gm/roll

50gm roll of ligature steel wire fastens archwires into brackets.

Diameter	Code
0.2mm	#994477
0.25mm	#994478
0.30mm	#994479



Heavy I



Heavy II



Light II Extra Long



Light II

\$8.75 /pack

J Hooks

Special Buy 4 @ \$7.95/pack
2 pcs/pack

Made from high quality stainless steel. Designed to pull anterior teeth in and backwards, and to help to move posterior teeth distally.

Force	85mm	78mm	65mm
Heavy I	#995882		
Heavy II	#995883		
Light II Extra Long		#995884	
Light II			#995885



\$19.50 /pack

Ligature Wire
Special Buy 4 @ \$17.70/pack
 100 pcs/pack

Ligature soft stainless steel wire used to hold/ligate archwires to brackets or tie segments of teeth together.

Size	Code
Short	#995887
Long	#995886



\$6.95 /pack

Lingual Cleats
Special Buy 4 @ \$6.35/pack
 10 pcs/pack

A versatile cleat formed by stainless steel. Ends may be raised or lowered as required to engage auxiliaries. Edges and corners rounded for patient comfort.

Size	Code
Short Arm	#995898
Long Arm	#995899

Lingual Sheaths
Special Buy 4 @ \$8.05/pack
 10 pcs/pack

Stainless steel lingual sheaths for attaching accessories such as transpalatal arches NiTi molar rotators and expanders.

\$8.45 /pack



Without hook and indent	Without hook with indent	With hook and indent Size: Distal L	With hook and indent Size: Distal R
Code #995905	Code #995906	Code #995907	Code #995908



\$4.55 /pack

Lingual Retainers - Bondable
Special Buy 4 @ \$4.05/pack
 2 pcs/pack

Bondable lingual splints which extend from cuspid to cuspid or can be shortened to retain any combination of adjacent teeth between cuspids.

Size	29mm	31mm	33mm	35mm	37mm	38mm	40mm	42mm	45mm	47mm
Upper						#995888	#995889	#995890	#995891	#995892
Lower	#995893	#995894	#995895	#995896	#995897					



\$36.95 each

Double Ended Positioning Gauge
Special Buy 4 @ \$33.55 each
 2 pcs/bag

This gauge is placed on the incisal/occlusal surface of the tooth to simplify bracket positioning. Measures 2.0mm, 2.5mm, 3.0mm, 3.5mm and, 3.5mm, 4.0mm, 4.5mm 5.0mm.

Code #994476



\$13.75 each

Cross Bracket Positioning Gauge
Special Buy 4 @ \$12.95 each

This gauge is placed on the incisal/occlusal surface of the tooth to simplify bracket positioning. Measures 3.5mm, 4mm, 4.5mm and 5mm.

Code #996147



\$8.45 /pack

Lingual Buttons
Special Buy 4 @ \$8.05/pack
 10 pcs/pack

Lingual buttons assist springs, wires and elastic ligatures for traction and tooth movement. Buttons can be fixed directly onto tooth using resins.

Size	Weldable	Bondable Mesh Wings	Bondable Mesh Single	Bondable Eyelets	Bondable
3.48mm x 2.5mm			#995902		
4.0mm x 2.6mm	#995900				
Ø 3.0mm					#995904
Ø 3.5mm		#995901		#995903	



\$50.00 each

Ortho-Model Storage Box, Top-Load
Special Buy 4 @ \$45.50 each

A practical and space-saving way to store orthodontics models. Each storage box holds up to 80 models. It has 4 tray layers. Each tray holds 20 models. Easy and quick to assemble.
 Size: 515mm (L) x 495mm (W) x 316mm (H)

Code #993437 Colour White



\$81.25 each

Ortho-Model Drawer System
Special Buy 4 @ \$73.85 each

A practical and space-saving way to store orthodontics models. Each storage box holds up to 80 models. It has 4 tray layers. Each tray holds 20 models. Easy and quick to assemble.
 Size: 490mm (L) x 468mm (W) x 400mm (H)

Code #993438 Colour White

Photography Mirrors

Assorted rhodium coated mirrors to assist dental professionals take intraoral photos.

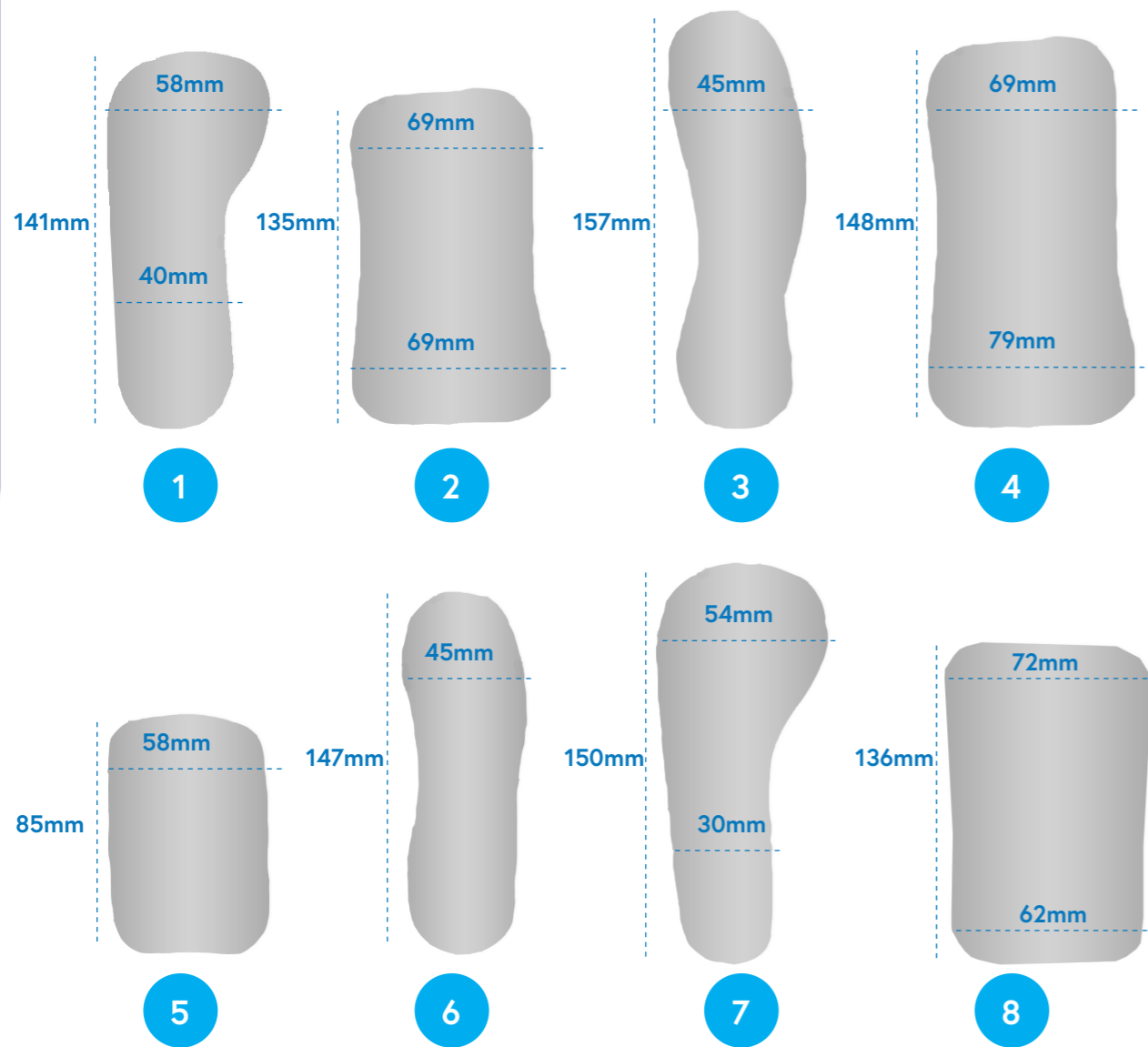

Type	Regular Price	Special Price	Single-Sided
1	\$29.95 each	Buy 4 @ \$26.35 each	#996131
2	\$29.95 each	Buy 4 @ \$26.35 each	#996132
3	\$29.95 each	Buy 4 @ \$26.35 each	#996133
4	\$29.95 each	Buy 4 @ \$26.35 each	#996134
5	\$29.95 each	Buy 4 @ \$26.35 each	#996135
6	\$29.95 each	Buy 4 @ \$26.35 each	#996136
7	\$29.95 each	Buy 4 @ \$26.35 each	#996137
8	\$29.95 each	Buy 4 @ \$26.35 each	#996138

Photography Mirrors

Assorted rhodium coated mirrors to assist dental professionals take intraoral photos.

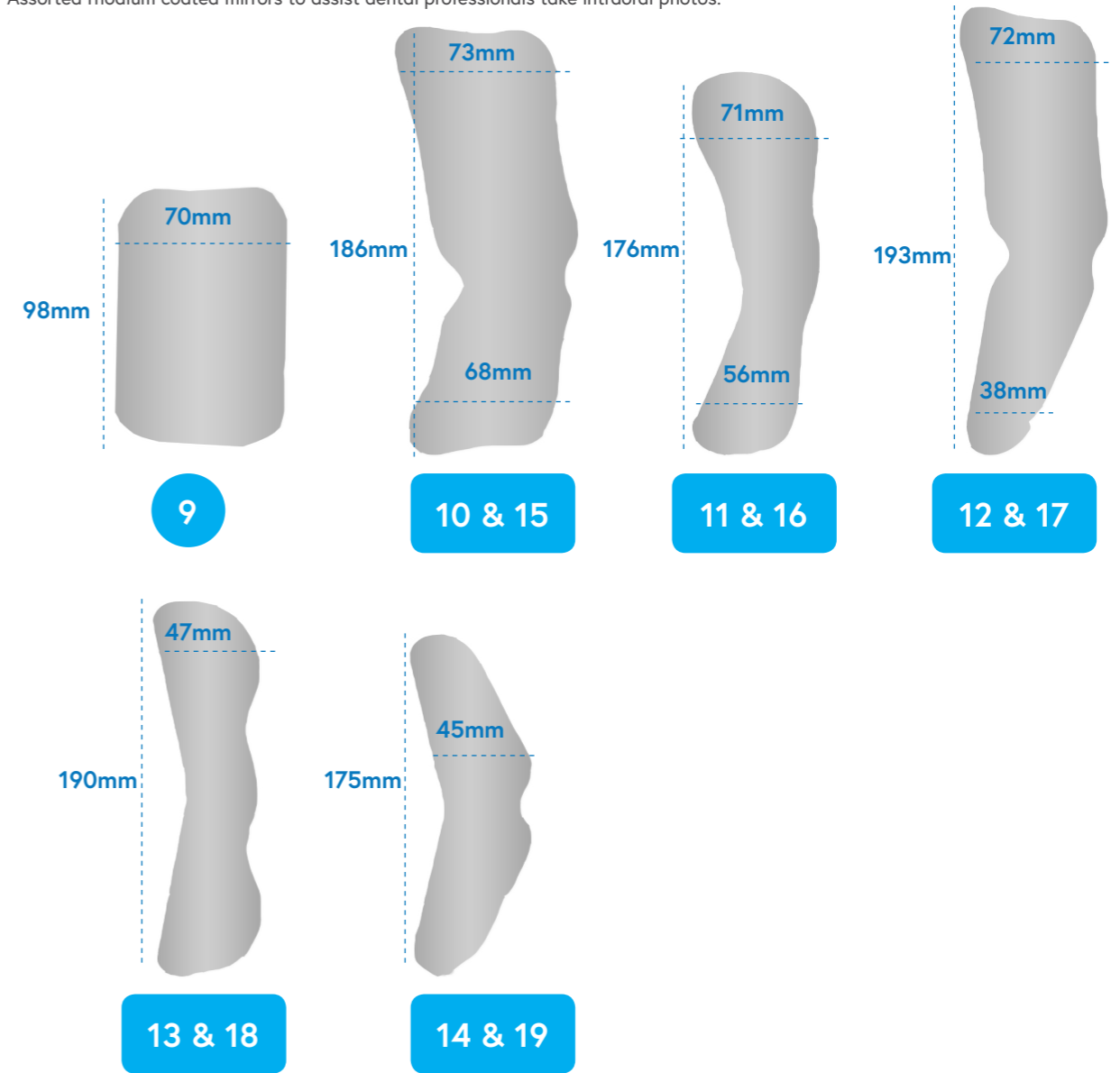

Type	Regular Price	Special Price	Single-Sided
9	\$29.95 each	Buy 4 @ \$26.35 each	#996139
10	\$29.95 each	Buy 4 @ \$26.35 each	#996124
11	\$29.95 each	Buy 4 @ \$26.35 each	#996125
12	\$29.95 each	Buy 4 @ \$26.35 each	#996126
13	\$29.95 each	Buy 4 @ \$26.35 each	#996127
14	\$29.95/pack	Buy 4 @ \$26.35 each	#996128

Type	Regular Price	Special Price	Double-Sided
15	\$39.95 each	Buy 4 @ \$36.35 each	#996140
16	\$39.95 each	Buy 4 @ \$36.35 each	#996141
17	\$39.95 each	Buy 4 @ \$36.35 each	#996142
18	\$39.95 each	Buy 4 @ \$36.35 each	#996143
19	\$39.95 each	Buy 4 @ \$36.35 each	#996144



Shoot XT-103C Macro LED Ring Flash Light

Special Buy 4 @ \$126.95 each

This Macro LED Ring Flash Light allows dental professionals to take clearer intraoral photos than ever before without unwanted shadows. It produces bright, HD-friendly soft light and flicker-free LED light output. Fits camera lens with diameter of 52mm, 55mm, 58mm, 62mm, 67mm, 72mm and 77m. Comes with 8pcs of adapter rings.



Adapter Rings

Code
#996145

\$139.65
each

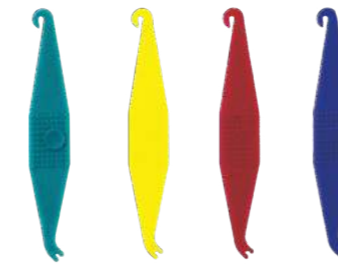

\$12.05
/bag

Elastic Ligature Directors

Special Buy 4 @ \$10.95/bag

100pcs/bag

Assorted colours of green, yellow, red and blue.

Code	Colour
#993373	Assorted



\$0.77
/bag

Elastics

Special Buy 4 @ \$0.70/bag

100pcs/bag

Medium type (3.5 oz. / 99.22 gm).

Size	Code
1/8"	#993368
3/16"	#993369
1/4"	#993370
5/16"	#993371
3/8"	#993372

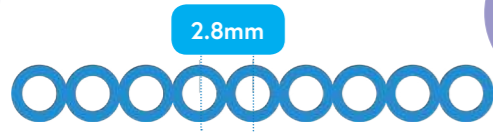

\$8.15
/spool

Power Chain - Continuous

Special Buy 4 @ \$7.35/spool

4.572 metres/spool

Super-elastic with superior colour that does not fade out.

Code	Colour
#993374	Clear
#993375	White
#993376	Blue
#993377	Red
#993378	Pink
#993379	Yellow
#993392	Lake Blue
#993393	Silver
#993394	Purple
#993395	Green

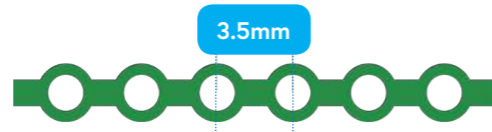

\$8.15
/spool

Power Chain - Short

Special Buy 4 @ \$7.35/spool

4.572 metres/spool

Super-elastic with superior colour that does not fade out.

Code	Colour
#993380	Clear
#993381	White
#993382	Blue
#993383	Red
#993384	Pink
#993385	Yellow
#993396	Lake Blue
#993397	Silver
#993398	Purple
#993399	Green



\$37.95
each

Orthodontic Face Mask

Special Buy 4 @ \$34.55 each

Made from high quality stainless steel and plastic with leather padded contact points for maximum patient comfort. Fully adjustable. Hexagon key included.

Code	Colour
#994473	Blue
#996148	Red



\$105.65
each

Dry Field System

Special Buy 4 @ \$96.05 each

Eliminates saliva and fully exposes both dental arches making it ideal for all bonding applications. The System is easy to assemble and can be inserted and used by a single operator. Autoclavable.

Size	Colour	Code
Small	Red	#994474
Large	White	#994475

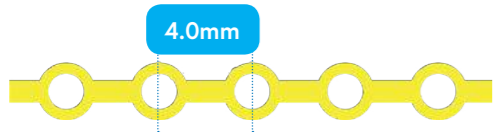

\$8.15
/spool

Power Chain - Long

Special Buy 4 @ \$7.35/spool

4.572 metres/spool

Super-elastic with superior colour that does not fade out.

Code	Colour
#993386	Clear
#993387	White
#993388	Blue
#993389	Red
#993390	Pink
#993391	Yellow
#993440	Lake Blue
#993441	Silver
#993442	Purple
#993443	Green



\$8.15
/bag

Elastomeric Ligature Ties

Special Buy 4 @ \$7.35/bag

26 ties x 40pcs/bag

Super-elastic with superior colour that does not fade out.

Code	Colour
#993403	Clear
#993404	White
#993405	Blue
#993406	Red
#993407	Pink
#993408	Yellow
#994059	Lake Blue
#994060	Silver
#994061	Purple
#994062	Green



\$24.15
/box

Plastic Bonding Trays

Special Buy 4 @ \$21.95/box

25pcs/box

With adhesives to hold brackets in place. Can hold one full bracket set-up. With or without mixing wells.

Code	Colour
#993430	D. Blue
#993431	White
#993432	Green
#993433	Teal



\$1.60
each

Disposable Appliance Cushion Pack

Special Buy 4 @ \$1.45 each

Used to keep appliances such as retainers, dentures, mouthguards and splints. The cushions prevent appliances from damage during transit or delivery. Size: 100mm (L) x 110mm (W) x 80mm (H)

Code	Colour
#991184	Clear

"BSA" Thermoforming/Coping Polypropylene Clear Retainer Material - HARD

Made from a highly durable material that does not shrink, crack or break. Offers excellent formability, flexibility and superior strength. Ideal for fabrication of aligners and retainers. Also used to form other appliances such as splints, nightguards, positioners and temporary anterior bridges.

*Note: To use, please remove the pink protective films.

- BPA Free
- Non-Latex
- Does not bond to acrylics



SQUARE SIZE: 127mm (L) x 127mm (W)				
Thickness	Quantity	Regular Price	Special Price	Code
0.5mm	40pcs/bag	\$32.50/bag	Buy 4 @ \$29.50/bag	#994260
0.75mm	30pcs/bag	\$32.50/bag	Buy 4 @ \$29.50/bag	#994261
1.0mm	25pcs/bag	\$32.50/bag	Buy 4 @ \$29.50/bag	#994262
1.5mm	15pcs/bag	\$32.50/bag	Buy 4 @ \$29.50/bag	#994263
2.0mm	12pcs/bag	\$32.50/bag	Buy 4 @ \$29.50/bag	#994264
3.0mm	7pcs/bag	\$32.50/bag	Buy 4 @ \$29.50/bag	#994265



ROUND SIZE: 125mm (Diameter)				
Thickness	Quantity	Regular Price	Special Price	Code
0.5mm	10pcs/bag	\$19.00/bag	Buy 4 @ \$17.70/bag	#994266
0.75mm	10pcs/bag	\$19.00/bag	Buy 4 @ \$17.70/bag	#994267
1.0mm	10pcs/bag	\$19.00/bag	Buy 4 @ \$17.70/bag	#994268

"BSA" Thermoforming/Coping Polypropylene Mouth Guard Material - SOFT

Made from a special formulated EVA plastic that is super soft and flexible. This material heats easily and conforms perfectly to the model. These custom-fit mouth guards allow for excellent oxygen intake.

*Note: To use, please remove the pink protective films.

- BPA Free
- Non-Latex
- Does not bond to acrylics



SQUARE SIZE: 127mm (L) x 127mm (W)				
Thickness	Quantity	Regular Price	Special Price	Code
0.5mm	35pcs/bag	\$32.50/bag	Buy 4 @ \$29.50/bag	#994269
1.0mm	25pcs/bag	\$32.50/bag	Buy 4 @ \$29.50/bag	#994270
1.5mm	15pcs/bag	\$32.50/bag	Buy 4 @ \$29.50/bag	#994271
2.0mm	13pcs/bag	\$32.50/bag	Buy 4 @ \$29.50/bag	#994272
3.0mm	11pcs/bag	\$32.50/bag	Buy 4 @ \$29.50/bag	#994273
3.8mm	10pcs/bag	\$32.50/bag	Buy 4 @ \$29.50/bag	#994274



ROUND SIZE: 120mm (Diameter)				
Thickness	Quantity	Regular Price	Special Price	Code
0.5mm	35pcs/bag	\$32.50/bag	Buy 4 @ \$29.50/bag	#994275
1.0mm	25pcs/bag	\$32.50/bag	Buy 4 @ \$29.50/bag	#994276
1.5mm	15pcs/bag	\$32.50/bag	Buy 4 @ \$29.50/bag	#994277
2.0mm	13pcs/bag	\$32.50/bag	Buy 4 @ \$29.50/bag	#994278
3.0mm	11pcs/bag	\$32.50/bag	Buy 4 @ \$29.50/bag	#994279
3.8mm	10pcs/bag	\$32.50/bag	Buy 4 @ \$29.50/bag	#994280

PREVENTATIVES



\$4.80 each

Children Animal Toothbrush
Special Buy 4 @ \$4.35 each

MUST BUY!

Kids will want to brush their teeth with these cute animal toothbrushes! The top part (head) of the toothbrush protects the bristles from dirt, and is a great way to store the toothbrush after use.

Type	Code
Frog	#990979
Tiger	#990980
Cow	#990981
Piggy	#990982
Hippo	#990983
Bull	#990984
Elephant	#990985
Sunny Bear	#990986
Brown Bear	#990987

PREVENTATIVES



\$22.15 /box

Toothbrush
Special Buy 4 @ \$20.15/box
20pcs/box
Each box comes with 20 flat toothbrushes in assorted colours of green, red, purple, beige and blue. Size: 160mm (L)

Code	Colour
#990989	Assorted

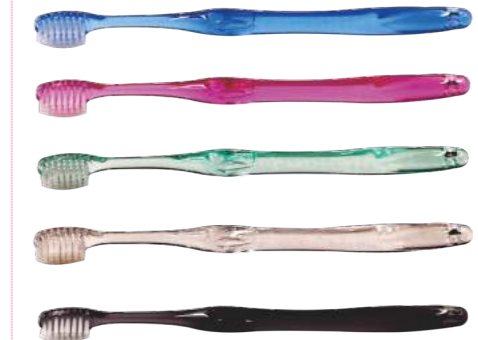

\$27.45 /box

Toothbrush
Special Buy 4 @ \$24.95/box
20pcs/box
Each box comes with 20 tapered toothbrushes in assorted colours of blue, pink, green, clear and black. Size: 185mm (L)

Code	Colour
#990991	Assorted

PREVENTATIVES

PREVENTATIVES

NuMedical

NuMedical



\$3.05 each

Denture Carebrush
Special Buy 4 @ \$2.75 each

Designed to effectively clean dentures. Bristled on 2 sides, tapered and serrated flat trim for better cleaning.

Code	Colour
#990977	Blue
#990978	Purple



\$21.95 /box

Toothbrush
Special Buy 4 @ \$19.95/box
18pcs/box

Each box comes with 18 tapered toothbrushes in assorted colours of white, blue and pink. Size: 165mm (L)

Code	Colour
#990988	Assorted



\$25.90 /box

Toothbrush
Special Buy 4 @ \$23.55/box
21pcs/box

Each box comes with 21 flat toothbrushes in assorted colours of blue, pink, green, yellow, brown, black and beige. Size: 185mm (L)

Code	Colour
#990990	Assorted

PREVENTATIVES

PREVENTATIVES



\$31.25 /bag

FREE SAMPLES!

Interdenal Brushes, 2 - 3mm

Special Buy 4 @ \$28.35/box

100pcs/bag

Tapered 2mm - 3mm interdenal brushes in assorted colours of purple, pink, yellow, blue and green.

Code	Colour
#990919	Assorted



\$31.25 /bag

FREE SAMPLES!

Interdenal Brushes, 3 - 4mm

Special Buy 4 @ \$28.35/box

100pcs/bag

Tapered 3mm - 4mm interdenal brushes in assorted colours of blue, grey, pink, green and brown.

Code	Colour
#990920	Assorted

PREVENTATIVES

PREVENTATIVES

MUST BUY!

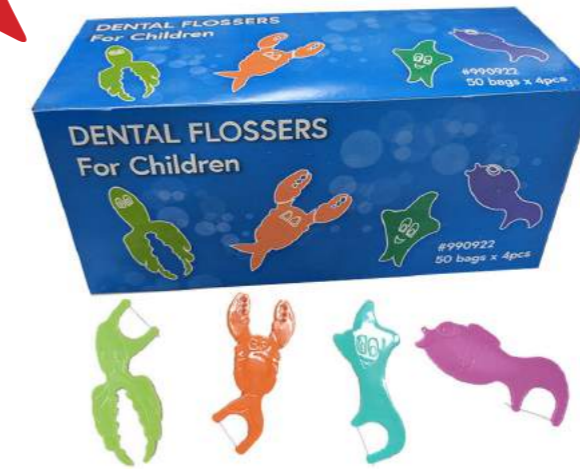

\$29.65 /box

FREE SAMPLES!

Kids Dental Flossers

Special Buy 4 @ \$26.95/box

200pcs/box

Under the sea themed dental flossers for the little ones! Each bag comes with 4 different sea creature flossers. Each box comes with 50 bags.

Code	Colour
#990922	Assorted



\$31.25 /bag

FREE SAMPLES!

Interdenal Brushes, 3 - 7mm

Special Buy 4 @ \$28.35/box

100pcs/bag

Tapered 3mm - 7mm interdenal brushes in assorted colours of yellow, orange, pink, blue and green.

Code	Colour
#990921	Assorted



\$27.55 /box

FREE SAMPLES!

Dental Flosser Picks

Special Buy 4 @ \$24.95/box

200pcs/box

White dental flosser picks. Each box is packed in 50 bags of 4 pieces.

Code	Colour
#990923	White



\$3.25 /box

FREE SAMPLES!

Prophy Brushes, Tapered

Special Buy 4 @ \$2.95/box

10pcs/box

With RA metal shanks. Latex-Free. Disposable.

Code	Colour
#990952	White



\$3.25 /box

FREE SAMPLES!

Prophy Brushes, Micro

Special Buy 4 @ \$2.95/box

10pcs/box

With RA metal shanks. Latex-Free. Disposable.

Code	Colour
#990954	White

NuMedical

NuMedical

PREVENTATIVES

PREVENTATIVES

PREVENTATIVES

PREVENTATIVES



\$3.25 /box

FREE SAMPLES!

Prophy Brushes, Nylon
Special Buy 4 @ \$2.95/box
 10pcs/box

With RA metal shanks. Latex-Free. Disposable.

Code	Colour
#990956	White



\$3.25 /box

FREE SAMPLES!

Prophy Brushes, Flat
Special Buy 4 @ \$2.95/box
 10pcs/box

With RA metal shanks. Latex-Free. Disposable.

Code	Colour
#990950	White



\$8.75 /bag

FREE SAMPLES!

Fluoride Tray, Double Arch, Large
Special Buy 4 @ \$7.95/bag
 50pcs/bag

Extremely comfortable, anatomically designed colour-coded trays.

Code	Colour
#990963	White



\$8.75 /bag

FREE SAMPLES!

Fluoride Tray, Double Arch, Medium
Special Buy 4 @ \$7.95/bag
 50pcs/bag

Extremely comfortable, anatomically designed colour-coded trays.

Code	Colour
#990964	Orange



\$2.60 each

Prophy Ring
Special Buy 4 @ \$2.35 each

Made from high grade stainless steel. For prophy, endo, etc. Autoclavable up to 135°C.

Code
#990900



\$1.80 /bag

Disposable Prophy Rings
Special Buy 4 @ \$1.60/bag
 20pcs/bag

Disposable prophy rings in assorted colours of white, purple, blue, yellow and green.

Code	Colour
#990901	Assorted



\$8.75 /bag

FREE SAMPLES!

Fluoride Tray, Double Arch, Small
Special Buy 4 @ \$7.95/bag
 50pcs/bag

Extremely comfortable, anatomically designed colour-coded trays.

Code	Colour
#990965	Yellow

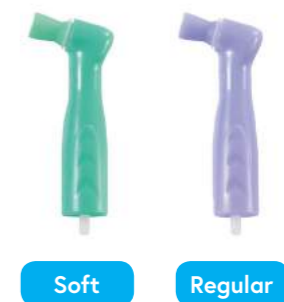

\$3.45 /bag

FREE SAMPLES!

Prophy Angles
Special Buy 4 @ \$3.15/bag
 10pcs/bag

Fits all standard handpieces. Reduce splatter and cross-contamination. Provide better visibility and contrast on teeth. Ergonomically designed with non-slip contour to reduce hand fatigue and micro-trauma.

Type	Code	Colour
Soft	#990917	Green
Regular	#990915	Purple

NuMedical

NuMedical

SUNDRIES



\$6.00 /pack

Retainer Box

Special Buy 4 @ \$5.45/pack

10pcs/pack

Size: 77mm x 63mm x 27mm

Code	Colour
#992641	Assorted



\$9.40 /pack

Multi-Purpose Box

Special Buy 4 @ \$8.55/pack

15pcs/pack

Size: 81mm x 72mm x 30mm

Code	Colour
#992644	Assorted



\$3.60 each

Hand Mirror

Special Buy 4 @ \$2.35 each

Light-weight single-sided mirror.
Size: 250mm (L) x 135mm (W)

Code	Colour
#993257	Blue
#993258	Red
#993259	Green
#993260	Yellow
#993261	White
#993262	Pink

SUNDRIES



\$3.90 each

Hand Mirror (with magnifier)

Special Buy 4 @ \$3.55 each

Double-sided mirror with 2x magnifier on one side. Size: 250mm (L) x 155mm (W)

Code	Colour
#993266	Silver



\$8.75 /pack

Denture Box

Special Buy 4 @ \$7.95/pack

10pcs/pack

Size: 96mm x 64mm x 55mm

Code	Colour
#992643	Assorted



\$15.80 /pack

Denture Box

Special Buy 4 @ \$14.35/pack

12pcs/pack

Size: 130mm x 71mm x 54mm

Code	Colour
#992652	Assorted



\$13.60 /pack

Rinsing Basket

Denture Carebath

Special Buy 4 @ \$12.35/pack

10pcs/pack

Size: 90mm x 76mm x 56mm

Code	Colour
#992642	Assorted



\$3.25 each

Dental Cold Packs

Special Buy 4 @ \$2.95 each

Size: 110mm x 70mm

Code	Colour
#993248	Blue
#993249	Pink
#993250	Yellow



\$19.50 /pack

Stickers for Children

Special Buy 4 @ \$17.50/pack

X - Special Buy 10 @ \$14.50/pack

10 sheets/pack

Cute stickers for children that are sure to win some smiles! Each sheet comes with 10 different sticker designs. The round tooth stickers are 5cm in diameter.

Code
#993263

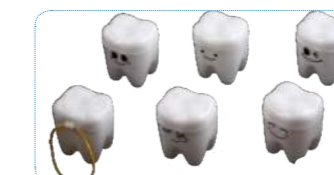

\$10.75 /pack

MUST BUY!

Milk Teeth Storage

Special Buy 4 @ \$9.75/pack

50pcs/pack

Comes with 50 pieces of milk teeth holders and cute smiley stickers.
Size: 40mm x 35mm x 48mm

Code	Colour
#992648	White

SUNDRIES

SUNDRIES

NuMedical

NuMedical



\$153.00 /set

3-Bottle Dental Medicine Storage Set

Special Buy 4 @ \$139.00/set

Designed for hygienic storage of precise medicine dosage. Made from high quality stainless steel with silicone-padded base, anti-slide. Autoclavable up to 135°. Size: 100mm (L) x 41mm (W) x 43mm (H)

Code #990846



\$3.90 each

Dental Medicine Bottle

To store dental medicine. Designed to be inserted into the 3-Bottle Dental Medicine Storage Set (#990846).

Code Colour #990847 Yellow Tint



\$2.30 each

Round Basin

Special Buy 4 @ \$2.10 each

Self-lubricating, high-gloss surface to help prevent staining. Works great for hygiene and exam set up. Contains Antimicrobial Protection. Surface Disinfect. Washer-disinfect. Reusable. Size: 100mm (H) x 330mm (Diameter)

Code	Colour
#994207	Yellow
#994208	Peach
#994209	Blue



\$94.50 each

Grinding Box

Special Buy 4 @ \$86.00 each

Ideal for grinding and sand blasing. Retains flying debris. Size: 300mm (L) x 200mm (W) x 180mm (H)

Code Colour #993267 Clear



\$1.60 each

LED Light Ring

Special Buy 4 @ \$1.45 each

LED light ring provides a bright light source to illuminate the desired area.

Code #993246



\$7.85 /box

Emesis Basin

Special Buy 4 @ \$7.15 each

10pcs/box

Self-lubricating, high-gloss surface to help prevent staining. Works great for hygiene and exam set up. Contains Antimicrobial Protection. Autoclavable up to 135°. Reusable. Size: 250mm (L) x 100mm (W) x 50mm (H)

Code	Colour
#994204	Yellow
#994205	Peach
#994206	Blue



\$18.10 /bag

Instrument Tie

Special Buy 4 @ \$16.45/bag

6pcs/bag

Used to tie instruments together during sterilisation. Autoclavable up to 135°. Size: 100mm (L)

Code	Colour
#992968	Blue
#992969	Red
#992970	Green
#992971	Yellow
#992972	Purple



\$35.60 each

Handpiece Stand

Special Buy 4 @ \$32.35 each

Designed to keep and manage up to 8 handpieces. Size: 120mm (L) x 65mm (W) x 20mm (H)

Code #992967





\$2.15 each

Film Aligning System - Ring Type

Special Buy 4 @ \$1.95 each

Colour-coded film positioners for intraoral dental x-ray films for anterior, posterior and bite-wing examinations. Compatible with size 0, 1, 2 and 3 dental films. Right angle design ensures correct film/ cone alignment, prevents 'cone cutting'. Made from soft, light and flexible plastic with rounded corners for superior patient comfort. Autoclavable up to 135°.

Type	Code
Anterior	#991378
Bite Wing	#991379
Posterior	#991380



\$7.30 /bag

Film Aligning System - Bite Blocks

Special Buy 4 @ \$6.65/bag

25pcs/bag

Color-coded film positioners for intraoral dental x-ray films for anterior, posterior and bite-wing examinations. Compatible with size 0, 1, 2 and 3 dental films. Right angle design ensures correct film/ cone alignment, prevents 'cone cutting'. Made from soft, light and flexible plastic with rounded corners for superior patient comfort. Autoclavable up to 135°.

Type	Code
Anterior	#991384
Posterior	#991385
Bite Wing H1	#991386
Bite Wing H2	#991387
Bite Wing V1	#991388
Bite Wing V2	#991389



\$11.00 each

Film Aligning System - Arm Type

Special Buy 4 @ \$10.00 each

Colour-coded film positioners for intraoral dental x-ray films for anterior, posterior and bite-wing examinations. Compatible with size 0, 1, 2 and 3 dental films. Right angle design ensures correct film/ cone alignment, prevents 'cone cutting'. Made from soft, light and flexible plastic with rounded corners for superior patient comfort. Autoclavable up to 135°.

Type	Code
Anterior	#991381
Bite Wing	#991382
Posterior	#991383

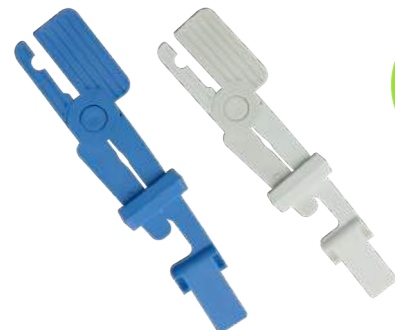

\$11.15 /box

Digital Sensor Holders

Special Buy 4 @ \$10.15/box

3pcs/box

Made from high-impact plastic; angle and position for anterior, scissor grip for posterior. Autoclavable up to 135°. Size: 125mm (L)

Code	Colour
#991357	Blue
#991358	White

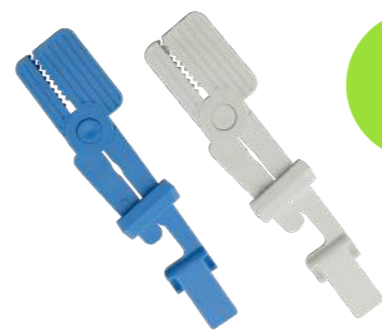

\$11.15 /box

Film Holders

Special Buy 4 @ \$10.15/box

3pcs/box

Made from high-impact plastic; angle and position for anterior, scissor grip for posterior. Autoclavable up to 135°. Size: 125mm (L)

Code	Colour
#991355	Blue
#991356	White



\$24.75 /bag

Film Hangers

Special Buy 4 @ \$22.50/bag

6pcs/bag

Made from stainless steel. Autoclavable up to 135°.

Code
#991354



\$147.59 each

LED X-Ray Viewer

Special Buy 4 @ \$134.50 each

LED Screen (203mm x 298mm). Luminance: 2000cd/m². Can be wall-mounted.

Code
#991359



#991361 - #991365



#991367 - #991369

\$5.90 /box

Digital Phosphor Plate Barrier Envelopes

Special Buy 4 @ \$5.35/box

100pcs/box

Disposable single-use envelopes provide a fluid-proof barrier to protect phosphor plates and prevent cross-contamination. Peel and stick closure provides a reliable seal and tear off easily using the tear-open tabs; vinyl material with a clear front and black back; clear size allows visual confirmation on the direction of the phosphor plate; textured surface reduces surface resistance, allowing the plate to slide in effortlessly; rounded corners for patient comfort;

Type	Inner Size	Outer Size	Code
#0	36mm (L) x 24mm (W)	46mm (L) x 28mm (W)	#991361
#1	43mm (L) x 28mm (W)	53mm (L) x 32mm (W)	#991362
#2	45mm (L) x 23mm (W)	55mm (L) x 38mm (W)	#991363
#3	57mm (L) x 31mm (W)	67mm (L) x 37mm (W)	#991364
#4	80mm (L) x 60mm (W)	93mm (L) x 65mm (W)	#991365
#0	25mm (L) x 37mm (W)	35.5mm (L) x 46mm (W)	#991367
#1	26.5mm (L) x 44mm (W)	37mm (L) x 53mm (W)	#991368
#2	33mm (L) x 45mm (W)	43mm (L) x 54mm (W)	#991369



Digital X-Ray Sensor Covers

These sensor covers are made from extra soft tear-resistant and leak-proof plastic material.

Size	Fitting	Quantity	Regular Price	Special Price	Code
200mm (L) x 35mm (W)	Size 1 & 2 Films	100pcs/box	\$1.50/box	Buy 4 @ \$1.35/box	#991371
200mm (L) x 43mm (W)	Size 3 Films	100pcs/box	\$1.50/box	Buy 4 @ \$1.35/box	#991372
200mm (L) x 64mm (W)	Size 3 Films	100pcs/box	\$1.50/box	Buy 4 @ \$1.35/box	#991373
100mm (L) x 42mm (W)	Size 3 Films	100pcs/box	\$0.72/box	Buy 4 @ \$0.65/box	#991374

LIKE

OUR PRODUCTS?

PLACE YOUR ORDERS HERE

www.numedical.com.au





**ORDER
ONLINE**

www.numedical.com.au



9-13 Hender Avenue Magill SA 5072
 Toll Free Call: 1300 998 224
 Toll Free Fax: 1300 998 234
 Email: orders@numedical.com.au

www.numedical.com.au

